

Color Fiber Amplifier Unit

E3NX-CA



**Smart Fiber Amplifier Units with White LEDs.
High Color Discrimination Capability with the Same
Easy Operation as Previous Fiber Amplifier Units.
Existing General-purpose Fiber Units Can Be
Connected.**

- Detects subtle color differences.
The new white LED optic system increases the light intensity and the low-noise circuit in the Smart Fiber Amplifier Unit provides a surprising detection capability.
- Handles glossy workpieces.
Smart Tuning lets you set the optimum sensitivity for detection with one simple operation.
- IoT compatible.
The detected RGB data can be displayed on the Amplifier Unit, and the Amplifier Unit for communications can transfer this data to the host in realtime.



For the most recent information on models that have been certified for safety standards, refer to your OMRON website.

Refer to *Safety Precautions* on page 12.

Ordering Information

Fiber Amplifier Units (Refer to *Dimensions* on pages 13 and 14.)

Type	Appearance	Connecting method	Inputs/outputs	Model	
				NPN output	PNP output
Standard models		Pre-wired (2 m)	1 output	E3NX-CA11 2M	E3NX-CA41 2M
		Wire-saving Connector	1 output	E3NX-CA6	E3NX-CA8
Advanced models		Pre-wired (2 m)	2 outputs + 1 input	E3NX-CA21 2M	E3NX-CA51 2M
Model for Sensor Communications Unit *		Connector for Sensor Communications Unit	---	E3NX-CA0	

* A Sensor Communications Unit is required if you want to use the Fiber Amplifier Unit on a network.
Note: Refer to your OMRON website for details on models with wire-saving connectors.

Fiber Units (Refer to *Dimensions* on page 14.)



Sensing method	Appearance	Sensing direction	Size	Model
Reflective		Right-angle	M6	E32-C91N 2M
Through-beam (Grooved type)		Array	10 mm	E32-G16 2M

Note: Refer to *Fiber Units* on your OMRON website or to the *Fiber Sensor Best Selection Catalog* (Cat. No. E418-E1) for details on Fiber Units.

Accessories (Sold Separately)

Wire-saving Connectors (Required for models for Wire-saving Connectors.) (Refer to Dimensions on page 15.)

Connectors are not provided with the Fiber Amplifier Unit and must be ordered separately. *Protective stickers are provided.

Type	Appearance	Cable length	No. of conductors	Model	Applicable Fiber Amplifier Units
Master Connector		2 m	3	E3X-CN11	E3NX-CA6 E3NX-CA8
Slave Connector			1	E3X-CN12	

Note: Models are also available with a 5-m cable. The model names have the suffix 5M. Ask your OMRON representative for delivery times.

Mounting Bracket (Refer to Dimensions on page 15.)

A Mounting Bracket is not provided with the Fiber Amplifier Unit. It must be ordered separately as required.

Appearance	Model	Quantity
	E39-L143	1

DIN Tracks (Refer to Dimensions on page 16.)

A DIN Track is not provided with the Fiber Amplifier Unit. It must be ordered separately as required.

Appearance	Type	Model	Quantity
	Shallow type, total length: 1 m	PFP-100N	1
	Shallow type, total length: 0.5 m	PFP-50N	
	Deep type, total length: 1 m	PFP-100N2	

Note: Refer to PFP-□ on your OMRON website for details.

End Plate (Refer to Dimensions on page 16.)

Two End Plates are provided with the Sensor Communications Unit.



End Plates are not provided with the Fiber Amplifier Unit. They must be ordered separately as required.

Appearance	Model	Quantity
	PFP-M	1

Note: Refer to PFP-M on your OMRON website for details.

Related Products

Sensor Communications Units

Type	Appearance	Model
Sensor Communications Unit for EtherCAT		E3NW-ECT
Distributed Sensor Unit *		E3NW-DS

Note: Refer to your OMRON website for details.

* The Distributed Sensor Unit can be connected to any of the Sensor Communications Units.

EtherCAT® is a registered trademark and patented technology, licensed by Beckhoff Automation GmbH, Germany.

Ratings and Specifications

Item	Type	Standard models		Advanced models	Model for Sensor Communications Unit *1	
		NPN output	E3NX-CA11	E3NX-CA6	E3NX-CA21	E3NX-CA0
		PNP output	E3NX-CA41	E3NX-CA8	E3NX-CA51	
Connecting method		Pre-wired	Wire-saving Connector	Pre-wired	Connector for Sensor Communications Unit	
I/O	Outputs	1 output		2 outputs	--- *3	
	External input	---		1 input *2		
Light source (wavelength)		White LED (420 to 700 nm)				
Supply voltage		10 to 30 VDC, including 10% ripple (p-p)			Supplied from the connector through the Sensor Communications Unit.	
Power consumption *4		At Power Supply Voltage of 24 VDC Normal mode: 960 mW max. (Current consumption: 65 mA max.) Eco function ON: 720 mW max. (Current consumption: 30 mA max.) Eco function LO: 800 mW max. (Current consumption: 33 mA max.)				
Control output		Load power supply voltage: 30 VDC max., open-collector output Load current: Groups of 1 to 3 Amplifiers: 100 mA max., Groups of 4 to 30 Amplifiers: 20 mA max. (Residual voltage: At load current of less than 10 mA: 1 V max. At load current of 10 to 100 mA: 2 V max.) OFF current: 0.1 mA max.			---	
Indications		7-segment displays (Sub digital display: green, Main digital display: white) Display direction: Switchable between normal and reversed. OUT indicator (orange), NO/NC indicator (orange), Smart Tuning indicator (blue), and OUT selection indicator (orange, only on models with 2 outputs)				
Protection circuits		Power supply reverse polarity protection, output short-circuit protection, and output reverse polarity protection			Power supply reverse polarity protection	
Sensing method		Contrast Mode: Light intensity discrimination for RGB (initial state/after 2-point tuning) (R+G+B light intensity discrimination for 1-point tuning) Color Mode: RGB ratio discrimination				
Response time	Super-high-speed Mode (SHS) *5	Operate or reset: 50 μs (only in Contrast Mode)				
	High-speed Mode (HS)	Operate or reset: 250 μs				
	Standard Mode (Stnd)	Operate or reset: 1 ms				
	Giga-power Mode (GIGA)	Operate or reset: 16 ms				
Sensitivity adjustment		Smart Tuning (2-point tuning, full autotuning, or 1-point tuning (1% to 99%)) or manual adjustment				
Maximum connectable Units		30 Units			30 Units (When connected to OMRON NJ-series Unit)	
No. of Units for mutual interference prevention *6	Super-high-speed Mode (SHS) *5	---				
	High-speed Mode (HS)	10 Units				
	Standard Mode (Stnd)	10 Units				
	Giga-power Mode (GIGA)	10 Units				

*1. The E3NW-ECT Sensor Communications Unit can be used, but the E3NW-CRT/CCL, E3X-DRT21-S, and E3X-CRT/ECT Sensor Communications Units cannot be used.

*2. The following details apply to the input.

	Contact input (relay or switch)	Non-contact input (transistor)
NPN	ON: Shorted to 0 V (Sourcing current: 2 mA max.). OFF: Open or shorted to Vcc.	ON: 1.5 V max. (Sourcing current: 2 mA max.) OFF: Vcc - 1.5 V to Vcc (Leakage current: 0.1 mA max.)
PNP	ON: Shorted to Vcc (Sinking current: 3 mA max.). OFF: Open or shorted to 0 V.	ON: Vcc - 1.5 V to Vcc (sinking current: 3 mA max.) OFF: 1.5 V max. (Leakage current: 0.1 mA max.)

*3. Two sensor outputs are allocated in the programmable logic controller (PLC) I/O table.
PLC operation via Communications Unit enables reading detected values and changing settings.

*4. Power consumption

At Power Supply Voltage of 10 to 30 VDC

Normal mode: 1,080 mW max. (Current consumption: 36 mA max. at 30 VDC, 74 mA max. at 10 VDC)

Eco function ON: 840 mW max. (Current consumption: 28 mA max. at 30 VDC, 50 mA max. at 10 VDC)

Eco function LO: 930 mW max. (Current consumption: 31 mA max. at 30 VDC, 55 mA max. at 10 VDC)

*5. The mutual interference prevention function is disabled if the detection mode is set to Super-high-speed Mode.

*6. The tuning will not change the number of units.

The least unit count among the mutual interference prevention units of E3NX and E3NC.

Check the mutual interference prevention unit count and response speed of each model.

Item	Type	Standard models		Advanced models	Model for Sensor Communications Unit *1
	NPN output	E3NX-CA11	E3NX-CA6	E3NX-CA21	E3NX-CA0
	PNP output	E3NX-CA41	E3NX-CA8	E3NX-CA51	
Connecting method	Pre-wired	Wire-saving Connector	Pre-wired	Connector for Sensor Communications Unit	
Functions	Operation mode	Contrast Mode: NO (Light-ON) or NC (Dark-ON) Color Mode: NO (ON for match: ON for same color as registered color) or NC (ON for mismatch: ON for different color from registered color)			
	Timer	Select from timer disabled, OFF-delay, ON-delay, one-shot, or ON-delay + OFF-delay timer (Counted by 0.1 s in a range of 0.1 to 0.5 ms, by 0.5 ms for 0.5 to 5 ms, and by 1 ms for 5 to 9999 ms. Default: 10 ms, Error: 0.1 ms)			
	Zero reset	Contrast Mode only Negative values can be displayed. (Threshold level is shifted.)			
	Resetting settings *7	Select from initial reset (factory defaults), user reset (saved settings), or bank reset.			
	Eco mode	Select from OFF (digital display lit), Eco ON (digital display not lit), and Eco LO (digital display dimmed).			
	Bank switching	Select from banks 1 to 8.			
	Power tuning level	Set from 100 to 9,999. (The RGB maximum incident level at Smart Tuning is adjusted to the power tuning level.)			
	Output 2	---	Normal, error output, AND output, or OR output		---
	External input	---	Select from input OFF, tuning, full-auto tuning, emission OFF, bank 1 and 2 switching, bank 1 through 8 switching, or zero reset.		---
Changing the displays	Threshold level and incident level, channel number and incident level, RGB display and incident level, or bank display and incident level				
Ambient illumination (Receiver side)	Incandescent lamp: 20,000 lx max., Sunlight: 30,000 lx max.				
Ambient temperature range	Operating: Groups of 1 or 2 Amplifier Units: -25 to 55°C, Groups of 3 to 10 Amplifier Units: -25 to 50°C, Groups of 11 to 16 Amplifier Units: -25 to 45°C, Groups of 17 to 30 Amplifier Units: -25 to 40°C Storage: -30 to 70°C (with no icing or condensation)			Operating: Groups of 1 or 2 Amplifier Units: 0 to 55°C, Groups of 3 to 10 Amplifier Units: 0 to 50°C, Groups of 11 to 16 Amplifier Units: 0 to 45°C, Groups of 17 to 30 Amplifier Units: 0 to 40°C Storage: -30 to 70°C (with no icing or condensation)	
Ambient humidity range	Operating and storage: 35% to 85% (with no condensation) within the surrounding air temperature range shown above				
Installation environment	Pollution degree 3 (as per IEC 60947-1)				
Insulation resistance	20 MΩ min. (at 500 VDC)				
Dielectric strength	1,000 VAC at 50/60 Hz for 1 minute				
Vibration resistance	10 to 55 Hz with a 1.5-mm double amplitude for 2 hours each in X, Y, and Z directions				
Shock resistance (destruction)	500 m/s ² for 3 times each in X, Y, and Z directions			150 m/s ² for 3 times each in X, Y, and Z directions	
Weight (packed state/Sensor only)	Approx. 115 g/ approx. 75 g	Approx. 60g/ approx. 20g	Approx. 115 g/approx. 75 g		Approx. 65 g/approx. 25 g
Materials	Case	Polycarbonate (PC)			
	Cover	Polycarbonate (PC)			
	Cable covering	Polyvinyl chloride (PVC)			---
Accessories	Instruction manual				

*7. The bank is not reset by the user reset function or saved by the user save function.

Sensing Distances

Specifications

Hex-shaped Models

Type			Appearance (mm)	Bending radius of cable (mm)	Sensing distance (mm)								Optical axis diameter (minimum sensing object) (mm)	Model
Sensing method	Size	Aperture angle			White paper				12-color discrimination					
			GIGA	ST	HS	SHS	GIGA	ST	HS	SHS				
Reflective	M6	60°		Flexible, R4	90	45	30	13	18	9	6	4	(0.05 dia.)	E32-C91N 2M

Through-beam Models (Grooved Type)

Type	Sensing width	Appearance (mm)	Bending radius of cable (mm)	Sensing distance (mm)								Model
				Opaque object				Translucent object				
				GIGA	ST	HS	SHS	GIGA	ST	HS	SHS	
Array	10 mm		R5	10								E32-G16 2M

Installation Information

Model	Installation			Cable						Emitter/receiver differentiation	Weight (packed state)
	Ambient temperature	Tightening torque	Mounting hole	Bending radius (mm)	Unbendable length (mm)	Tensile strength	Sheath material	Core material			
E32-C91N 2M	-40 to 70°C	0.98 N·m	6.2 ^{+0.5} ₀ dia.	R4	0	29.4 N	Polyethylene	Plastic	White line on emitter cable	36 g	
E32-G16 2M	-40 to 70°C	0.53 N·m	---	R5	0*	29.4 N	Polyethylene	Plastic	---	51 g	

* The bending radius of the protective cover (PVC, 25 mm) is 10 mm min.

Hex-shaped Models

Sensing method	Size	Aperture angle	Model	Sensing distance (mm)							
				Reflective: White paper, Through-beam: Opaque object				Reflective: 12-color discrimination, Through-beam: Translucent object *1			
				GIGA	Standard	High-speed	Super-high-speed	GIGA	Standard	High-speed	Super-high-speed *2
Through-beam	M4	15°	E32-LT11N 2M (Built-in Lens)	980	510	350	140	190	100	70	44
		60°	E32-T11N 2M	300	150	100	45	60	31	21	13
Reflective	M3	60°	E32-C21N 2M	54	27	18	7	10	5	3.6	2.6
			E32-D21N 2M	90	45	30	13	18	9	6	4
	M6	15°	E32-LD11N 2M (Built-in Lens)	88	44	29	13	17	8	5	4
			E32-C31N 2M	12	6	4	1.8	2.4	1.2	0.8	0.6
Retro-reflective for transparent object detection	M6	60°	E32-C11N 2M	90	45	30	13	18	9	6	4
			E32-LR11NP 2M (Built-in Lens) + E39-RP1 (Reflector, sold separately)	370	180	120	55	75	37	25	16

*1. These sensing distances are recommended to make the most of the detection capabilities of the Sensor.

*2. The Super-high-speed Mode for 12-color discrimination with a Reflective Sensor or for detection of translucent objects with a Through-beam Sensor can be set only in Contrast Mode. The Super-high-speed Mode can not be set in Color Mode.

Threaded Models

Sensing method	Size	Aperture angle	Model	Sensing distance (mm)							
				Reflective: White paper, Through-beam: Opaque object				Reflective: 12-color discrimination, Through-beam: Translucent object *1			
				GIGA	Standard	High-speed	Super-high-speed	GIGA	Standard	High-speed	Super-high-speed *2
Through-beam	M4	60°	E32-T11R 2M	300	150	100	45	60	31	21	13
			E32-LT11 2M (Built-in Lens)	1,150	600	410	170	230	120	82	52
		Reflective	M6	15°	E32-LT11R 2M (Built-in Lens)	980	510	350	140	190	100
E32-LD11 2M (Built-in Lens)	92				46	30	13	18	9	6	4
M3	60°		E32-LD11R 2M (Built-in Lens)	88	44	29	13	17	8	5	4
			E32-C31 2M	37	18	12	5	7	3.8	2.5	1.8
			E32-D11R 2M	90	45	30	13	18	9	6	4
M6	E32-CC200 2M	150	75	50	22	30	15	10	7		

Cylindrical Models

Sensing method	Sensing direction	Size	Model	Sensing distance (mm)							
				Reflective: White paper, Through-beam: Opaque object				Reflective: 12-color discrimination, Through-beam: Translucent object *1			
				GIGA	Standard	High-speed	Super-high-speed	GIGA	Standard	High-speed	Super-high-speed *2
Through-beam	Top-view	1.5 dia.	E32-T22B 2M	110	64	37	16	22	12	7	5
		3 dia.	E32-T12R 2M	300	150	100	45	60	31	21	13
	Side-view		E32-T14LR 2M	190	100	68	29	38	20	13	8
Reflective	Top-view	1.5 dia.	E32-D22B 2M	17	8	6	2.4	3	2	1.2	0.7
		3 dia.	E32-D221B 2M	38	20	13	5	7	4	3	1.7
			E32-D32L 2M	85	44	30	12	17	8	6	3.7

Flat Models

Sensing method	Sensing direction	Model	Sensing distance (mm)							
			Reflective: White paper, Through-beam: Opaque object				Reflective: 12-color discrimination, Through-beam: Translucent object *1			
			GIGA	Standard	High-speed	Super-high-speed	GIGA	Standard	High-speed	Super-high-speed *2
Through-beam	Flat-view	E32-LT35Z 2M (Built-in Lens)	360	190	130	55	73	38	26	16
	Top-view	E32-T15XR 2M	300	150	100	45	60	31	21	13
	Side-view	E32-T15YR 2M	190	100	68	29	38	20	13	8
	Flat-view	E32-T15ZR 2M	190	100	68	29	38	20	13	8
Reflective	Top-view	E32-D15XR 2M	90	45	30	13	18	9	6	4
	Side-view	E32-D15YR 2M	21	10	7	3.1	4.2	2.1	1.4	1
	Flat-view	E32-D15ZR 2M	21	10	7	3.1	4.2	2.1	1.4	1

Sleeve Models

Sensing method	Sensing direction	Model	Sensing distance (mm)							
			Reflective: White paper, Through-beam: Opaque object				Reflective: 12-color discrimination, Through-beam: Translucent object *1			
			GIGA	Standard	High-speed	Super-high-speed	GIGA	Standard	High-speed	Super-high-speed *2
Through-beam	Top-view	E32-TC200BR 2M	300	150	100	45	60	31	21	13
Reflective		E32-DC200BR 2M	90	45	30	13	18	9	6	4

*1. These sensing distances are recommended to make the most of the detection capabilities of the Sensor.

*2. The Super-high-speed Mode for 12-color discrimination with a Reflective Sensor or for detection of translucent objects with a Through-beam Sensor can be set only in Contrast Mode. The Super-high-speed Mode can not be set in Color Mode.

Small-spot, Reflective Models

Sensing method	Type	Spot diameter	Center distance (mm)	Model	Sensing distance (mm)							
					Reflective: White paper, Through-beam: Opaque object				Reflective: 12-color discrimination, Through-beam: Translucent object *1			
					GIGA	Standard	High-speed	Super-high-speed	GIGA	Standard	High-speed	Super-high-speed *2
Reflective	Integrated lens, long-distance, small-spot	6 dia.	50	E32-L15 2M	Spot diameter of 6 mm at 50 mm. Sensing distance of 40 to 100 mm.				Spot diameter of 6 mm at 50 mm. Sensing distance of 40 to 85 mm.		Spot diameter of 6 mm at 50 mm. Sensing distance of 40 to 60 mm.	
	Parallel light	4 dia.	0 to 20	E32-C31 2M + E39-F3C	Spot diameter of 4 mm at 0 to 20 mm.				Spot diameter of 4 mm at 1 to 9 mm. *3			
	Small-spot	0.5 dia.	7	E32-C31 2M + E39-F3A-5	Spot diameter of 0.5 mm at 7 mm.		---		Spot diameter of 0.5 mm at 7 mm. *3		---	
			17	E32-C31 2M + E39-F3B	Spot diameter of 0.5 mm at 17 mm.		---		---			
		3 dia.	50	E32-CC200 2M + E39-F18	Spot diameter of 3 mm at 50 mm.		---		Spot diameter of 3 mm at 50 mm. *3		---	

High-power Beam Models

Sensing method	Sensing direction	Aperture angle	Model	Sensing distance (mm)							
				Reflective: White paper, Through-beam: Opaque object				Reflective: 12-color discrimination, Through-beam: Translucent object *1			
				GIGA	Standard	High-speed	Super-high-speed	GIGA	Standard	High-speed	Super-high-speed *2
Through-beam	Top-view	10°	E32-T17L 10M	8,570	200	130	59	1,710	40	27	17
	Side-view	30°	E32-T14 2M	1,910	990	680	290	380	190	130	87
	Right-angle	12°	E32-T11N 2M +E39-F1	1,470	760	520	220	290	150	100	66
	Top-view	12°	E32-T11R 2M +E39-F1	1,470	760	520	220	290	150	100	66
	Side-view	60°	E32-T11R 2M +E39-F2	180	98	67	28	37	19	13	8
	Top-view	12°	E32-T11 2M +E39-F1	2,430	1,260	860	360	480	250	170	110
	Side-view	60°	E32-T11 2M +E39-F2	310	160	110	47	62	32	22	14
	Top-view	12°	E32-T61-S 2M +E39-F1	1,080	560	380	160	210	110	76	49
	Side-view	60°	E32-T61-S 2M +E39-F2	130	72	49	21	27	14	9	6

Narrow View Models

Sensing method	Sensing direction	Aperture angle	Model	Sensing distance (mm)							
				Reflective: White paper, Through-beam: Opaque object				Reflective: 12-color discrimination, Through-beam: Translucent object *1			
				GIGA	Standard	High-speed	Super-high-speed	GIGA	Standard	High-speed	Super-high-speed *2
Through-beam	Side-view	4°	E32-T24S 2M	750	380	260	110	150	77	53	34
			E32-T22S 2M	1,070	550	380	160	210	110	76	48

Chemical-resistant, Oil-resistant Models

Sensing method	Type	Sensing direction	Model	Sensing distance (mm)							
				Reflective: White paper, Through-beam: Opaque object				Reflective: 12-color discrimination, Through-beam: Translucent object *1			
				GIGA	Standard	High-speed	Super-high-speed	GIGA	Standard	High-speed	Super-high-speed *2
Through-beam	Chemical/oil resistant	Top-view	E32-T12F 2M	1,710	880	600	260	340	170	120	78
			E32-T11F 2M	250	130	91	39	51	26	18	11
		Side-view	E32-T14F 2M	210	110	76	32	42	22	15	9
	Chemical/oil-resistant at 150°C	Top-view	E32-T51F 2M	770	400	270	110	150	80	54	35
Reflective	Chemical/oil resistant	Top-view	E32-D12F 2M	49	24	16	7	9	5	3	2.4
	Chemical-resistant cable		E32-D11U 2M	90	45	30	13	18	9	6	4

*1. These sensing distances are recommended to make the most of the detection capabilities of the Sensor.

*2. The Super-high-speed Mode for 12-color discrimination with a Reflective Sensor or for detection of translucent objects with a Through-beam Sensor can be set only in Contrast Mode. The Super-high-speed Mode can not be set in Color Mode.

*3. The sensing distances are given for Contrast Mode. The sensing distance cannot be set in Color Mode.

Bending-resistant Models

Sensing method	Size	Model	Sensing distance (mm)							
			Reflective: White paper, Through-beam: Opaque object				Reflective: 12-color discrimination, Through-beam: Translucent object *1			
			GIGA	Standard	High-speed	Super-high-speed	GIGA	Standard	High-speed	Super-high-speed *2
Through-beam	1.5 dia.	E32-T22B 2M	110	64	37	16	22	12	7	5
	M3	E32-T21 2M	100	57	33	14	20	11	6	4
	M4	E32-T11 2M	380	200	130	58	77	40	27	17
	Square	E32-T25XB 2M	77	43	25	10	15	8	5	3.3
Reflective	1.5 dia.	E32-D22B 2M	17	8	6	2.4	3	2	1.2	0.7
	M3	E32-D21 2M	17	8	6	2.4	3.4	1.8	1.2	0.7
	3 dia.	E32-D221B 2M	38	20	13	5	7	4	3	1.7
	M4	E32-D21B 2M	38	20	13	5	7	4	2.7	1.7
	M6	E32-D11 2M	90	45	30	13	18	9	6	4
	Square	E32-D25XB 2M	27	14	9	3.9	5	3	2	1.2

Heat-resistant Models

Sensing method	Heat-resistant temperature	Model	Sensing distance (mm)							
			Reflective: White paper, Through-beam: Opaque object				Reflective: 12-color discrimination, Through-beam: Translucent object *1			
			GIGA	Standard	High-speed	Super-high-speed	GIGA	Standard	High-speed	Super-high-speed *2
Through-beam	150°	E32-T51 2M	420	220	150	65	85	44	30	19
	200°	E32-T81R-S 2M	150	80	54	23	30	16	10	7
	350°	E32-T61-S 2M	250	130	91	39	51	26	18	11
Reflective	150°	E32-D51 2M	120	60	40	17	24	12	8	5
	200°	E32-D81R-S 2M	42	21	14	6	8	4.3	2.9	1.9
	350°	E32-D61-S 2M	42	21	14	6	8	4	2.9	1.9
	400°	E32-D73-S 2M	28	14	9	4	5	2.9	1.9	1.3

Area Detection Models

Sensing method	Type	Sensing width	Model	Sensing distance (mm)							
				Reflective: White paper, Through-beam: Opaque object				Reflective: 12-color discrimination, Through-beam: Translucent object *1			
				GIGA	Standard	High-speed	Super-high-speed	GIGA	Standard	High-speed	Super-high-speed *2
Through-beam	Area	11 mm	E32-T16PR 2M	480	250	170	73	96	50	34	21
			E32-T16JR 2M	410	210	140	63	83	43	29	19
		30 mm	E32-T16WR 2M	730	210	140	63	140	43	29	19
Reflective	Array	11 mm	E32-D36P1 2M	75	37	25	11	15	7	5	3.3

Vacuum-resistant Models

Sensing method	Type	Heat-resistant temperature	Model	Sensing distance (mm)							
				Reflective: White paper, Through-beam: Opaque object				Reflective: 12-color discrimination, Through-beam: Translucent object *1			
				GIGA	Standard	High-speed	Super-high-speed	GIGA	Standard	High-speed	Super-high-speed *2
Through-beam	Vacuum side	120°	E32-T51V 1M	110	57	39	16	22	11	7	5
			E32-T51V 1M+E39-F1V	170	90	61	26	34	18	12	7
		200°	E32-T84SV 1M	270	140	97	41	54	28	19	12

*1. These sensing distances are recommended to make the most of the detection capabilities of the Sensor.

*2. The Super-high-speed Mode for 12-color discrimination with a Reflective Sensor or for detection of translucent objects with a Through-beam Sensor can be set only in Contrast Mode. The Super-high-speed Mode can not be set in Color Mode.

Engineering Data (Reference Value)

Color vs. Detection Capability

E3NX-CA□□ + E32-CC200

	White	Red	Yellow/red	Yellow	Yellow/green	Green	Blue/green	Blue	Blue/purple	Purple	Red/purple	Black*
White		○	○	○	○	○	○	○	○	○	○	(○)
Red	○		○	○	○	○	○	○	○	○	○	○
Yellow/red	○	○		○	○	○	○	○	○	○	○	○
Yellow	○	○	○		○	○	○	○	○	○	○	○
Yellow/green	○	○	○	○		○	○	○	○	○	○	○
Green	○	○	○	○	○		○	○	○	○	○	○
Blue/green	○	○	○	○	○	○		○	○	○	○	○
Blue	○	○	○	○	○	○	○		○	○	○	○
Blue/purple	○	○	○	○	○	○	○	○		○	○	○
Purple	○	○	○	○	○	○	○	○	○		○	○
Red/purple	○	○	○	○	○	○	○	○	○	○		○
Black*	(○)	○	○	○	○	○	○	○	○	○	○	

High-speed Mode

Sensing distance: 10 mm (i.e., tuning distance)

○: Detection possible, x: Detection not possible.

* Use Contrast Mode to distinguish between white and black.

Correlation vs. Distance

E3NX-CA + E32-CC200

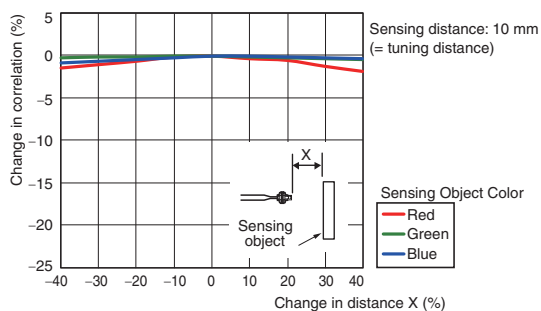

Correlation vs. Angle

E3NX-CA + E32-CC200

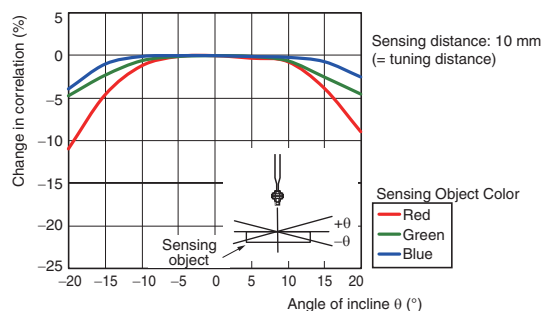

Spot Diameter vs. Sensing Distance

E3NX-CA + E32-L15

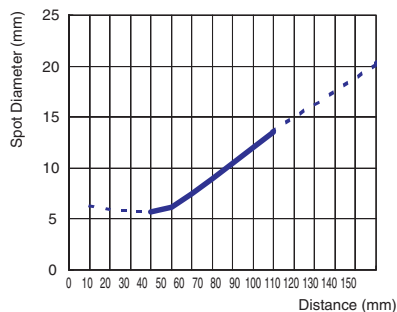

E3NX-CA

I/O Circuit Diagrams

NPN Output

Model	Operation mode	Timing chart	NO/NC indicator	Output circuit
E3NX-CA11 E3NX-CA21 E3NX-CA6	NO (Light-ON)	Incident light: ON (green bar) No incident light: OFF (white bar) Operation indicator (orange): ON (green bar) OFF (white bar) Output transistor: ON (green bar) OFF (white bar) Load Operate (e.g., relay): ON (green bar) Reset (Between brown and black): OFF (white bar)	NO ON	
	NC (Dark-ON)	Incident light: ON (green bar) No incident light: OFF (white bar) Operation indicator (orange): ON (green bar) OFF (white bar) Output transistor: ON (green bar) OFF (white bar) Load Operate (e.g., relay): ON (green bar) Reset (Between brown and black): OFF (white bar)	NC ON	

* The CA11 and CA6 have only control output 1. These models do not have control output 2 or an external input, so they do not have the OUT2 indicator.

PNP Output

Model	Operation mode	Timing chart	NO/NC indicator	Output circuit
E3NX-CA41 E3NX-CA51 E3NX-CA8	NO (Light-ON)	Incident light: ON (green bar) No incident light: OFF (white bar) Operation indicator (orange): ON (green bar) OFF (white bar) Output transistor: ON (green bar) OFF (white bar) Load Operate (e.g., relay): ON (green bar) Reset (Between blue and black): OFF (white bar)	NO ON	
	NC (Dark-ON)	Incident light: ON (green bar) No incident light: OFF (white bar) Operation indicator (orange): ON (green bar) OFF (white bar) Output transistor: ON (green bar) OFF (white bar) Load Operate (e.g., relay): ON (green bar) Reset (Between blue and black): OFF (white bar)	NC ON	

* The CA41 and CA8 have only control output 1. These models do not have control output 2 or an external input, so they do not have the OUT2 indicator.

Note: 1. Timing Charts for Timer Function Settings (T: Set Time)

ON-delay Timer	OFF-delay Timer	One-shot Timer	ON/OFF-delay Timer
Delays the output ON after detection.	Holds the output ON for detection by PLC when the detection time is too short.	Keeps the output ON for a specified time regardless of the workpiece size variations.	Sets both OFF-delay Timer and ON-delay Timer.

2. Timing Chart for Control Output (AND or OR) (T: Set Time)

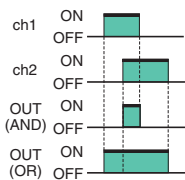

Nomenclature

Standard Models

E3NX-CA11/CA41/CA6/CA8

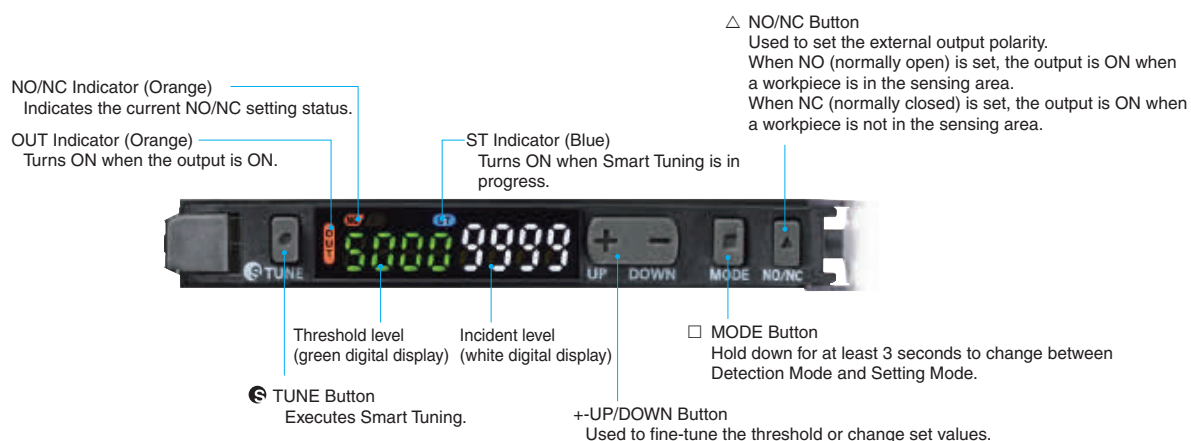

Advanced Models and Model for Sensor Communications Unit

E3NX-CA21/CA51/CA0

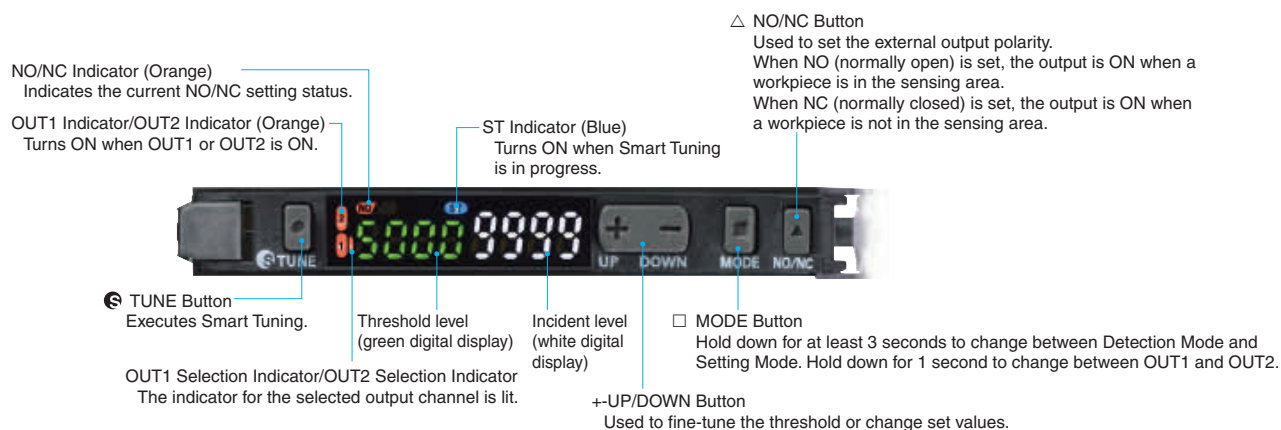



Safety Precautions

Be sure to read the precautions for all models in the website at: <http://www.ia.omron.com/>.

Warning Indications

 WARNING	Warning level Indicates a potentially hazardous situation which, if not avoided, will result in minor or moderate injury, or may result in serious injury or death. Additionally, there may be significant property damage.
Precautions for Safe Use	Supplementary comments on what to do or avoid doing, to use the product safely.
Precautions for Correct Use	Supplementary comments on what to do or avoid doing, to prevent failure to operate, malfunction or undesirable effect on product performance.

Meaning of Product Safety Symbols

	General prohibition Indicates the instructions of unspecified prohibited action.
	Caution, explosion Indicates the possibility of explosion under specific conditions.
	Caution, fire Indicates the possibility of fire under specific conditions.

WARNING

This product is not designed or rated for ensuring safety of persons either directly or indirectly. Do not use it for such purposes.



Do not use the product with voltage in excess of the rated voltage. Excess voltage may result in malfunction or fire.



Never use the product with an AC power supply. Otherwise, explosion may result.



Precautions for Safe Use

The following precautions must be observed to ensure safe operation of the product. Doing so may cause damage or fire.

1. Do not install the product in the following locations.
 - Locations subject to direct sunlight
 - Locations subject to condensation due to high humidity
 - Locations subject to corrosive gas
 - Locations subject to vibration or mechanical shocks exceeding the rated values
 - Locations subject to exposure to water, oil, chemicals
 - Locations subject to steam
 - Locations subject to strong magnetic field or electric field
2. Do not use the product in environments subject to flammable or explosive gases.
3. Do not use the product in any atmosphere or environment that exceeds the ratings.
4. To secure the safety of operation and maintenance, do not install the product close to high-voltage devices and power devices.
5. High-Voltage lines and power lines must be wired separately from this product. Wiring them together or placing them in the same duct may cause induction, resulting in malfunction or damage.
6. Do not apply any load exceeding the ratings. Otherwise damage or fire may result.
7. Do not short the load. Otherwise damage or fire may result.
8. Connect the load correctly.
9. Do not miswire such as the polarity of the power supply.

10. Do not use the product if the case is damaged.
11. Burn injury may occur. The product surface temperature rises depending on application conditions, such as the ambient temperature and the power supply voltage. Attention must be paid during operation or cleaning.
12. When setting the sensor, be sure to check safety such as by stopping the equipment.
13. Be sure to turn off the power supply before connecting or disconnecting wires.
14. Do not attempt to disassemble, repair, or modify the product in any way.
15. When disposing of the product, treat it as industrial waste.
16. Do not use the Sensor in water, rain, or outdoors.
17. UL Standard Certification

Only the Sensors with the Enhanced UL Certification Mark are certified by UL. They are intended to be supplied by a "Class 2 circuit". When used in United States and Canada, please use the same Class 2 source for input and output. The overcurrent protection current rating is 2 A max. They were evaluated as Open type and shall be installed within a enclosure.

Precautions for Correct Use

1. Be sure to mount the unit to the DIN track until it clicks.
2. When using the Amplifier Units with Wire-saving Connectors, attach the protective stickers (provided with E3X-CN-series Connectors) on the unused power pins to prevent electrical shock and short circuiting. When using Amplifier Units with Connectors for Communications Units, attach the protective caps (provided with E3NW-series Sensor Communications Units).

Amplifier Unit with Wire-saving Connector

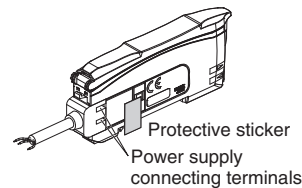

Amplifier Unit with Connector for Communications Unit

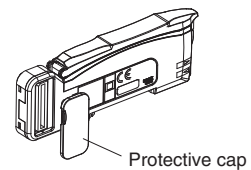

3. Use an extension cable with a maximum length of 30 m. Be sure to use a cable of at least 0.3 mm² for extension. The power voltage must be 24 to 30 V when connecting Amplifier Units with extension cable and wire-saving connector.
4. Do not apply the forces on the cable exceeding the following limits:
Pull: 40 N; torque: 0.1 N·m; pressure: 20 N; bending: 29.4 N
5. Use the E32-□□ Fiber Unit.
6. Do not apply excessive force such as tension, compression or torsion to the Fiber Amplifier Unit with the Fiber Unit fixed to the Fiber Amplifier Unit.
7. Always keep the protective cover in place when using the product. Not doing so may cause malfunction.
8. It may take time until the incident level and measurement value become stable immediately after the power is turned on depending on use environment.
9. The product is ready to operate 200 ms after the power supply is turned ON.
10. The Mobile Console E3X-MC11, E3X-MC11-SV2 and E3X-MC11-S cannot be connected.
11. The mutual interference prevention function does not work when in combination with E3C/E2C/E3X.
12. Excessive incident light cannot be sufficiently handled by the mutual interference prevention function and may cause malfunction. To prevent this, set a higher threshold level.
13. The Communication Unit E3X-DRT21-S, E3X-CRT, E3X-ECT and E3NW cannot be connected.
14. If you notice an abnormal condition such as a strange odor, extreme heating of the unit, or smoke, immediately stop using the product, turn off the power, and consult your dealer.
15. Do not use thinner, benzene, acetone, and lamp oil for cleaning.

Dimensions

Fiber Amplifier Units

Pre-wired Amplifier Units

E3NX-CA11

E3NX-CA41

E3NX-CA21

E3NX-CA51

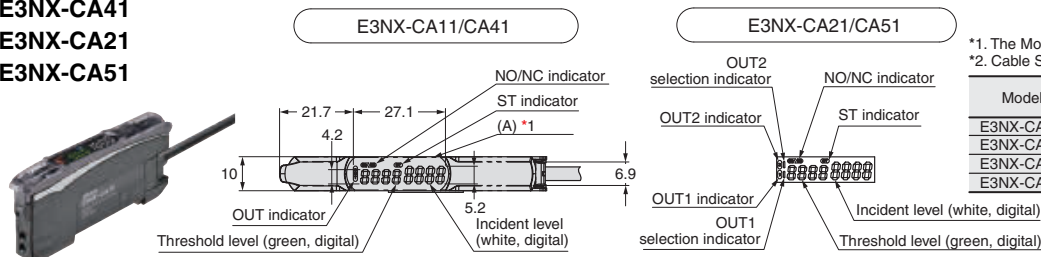

*1. The Mounting Bracket can also be used on side A.
*2. Cable Specifications

Model	Outer diameter	No. of conductors	Others
E3NX-CA11	4.0 dia.	3	Conductor cross-section: 0.2 mm ² Insulator dia.: 0.9 mm
E3NX-CA41			
E3NX-CA21			
E3NX-CA51	5		

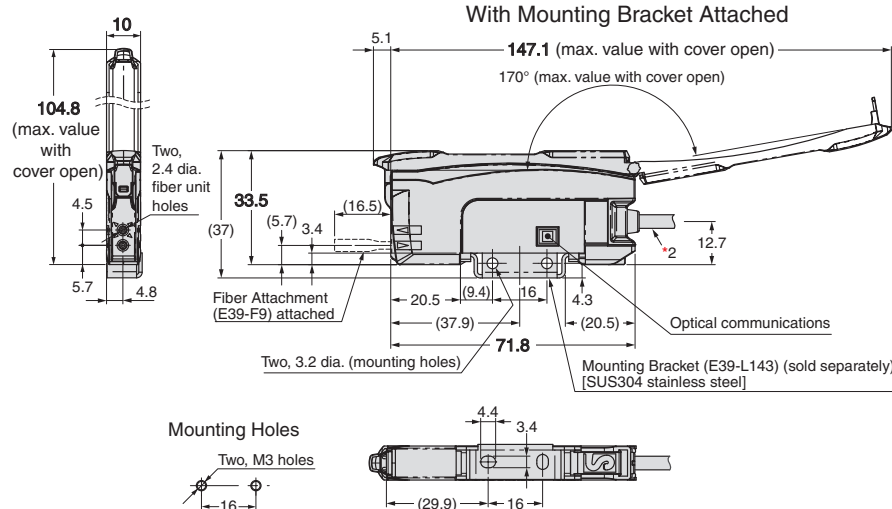

Standalone Product Diagram

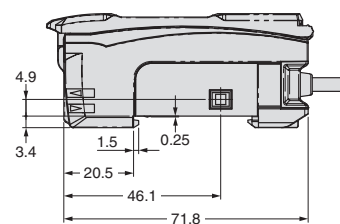

Amplifier Units with Wire-saving Connectors

E3NX-CA6

E3NX-CA8

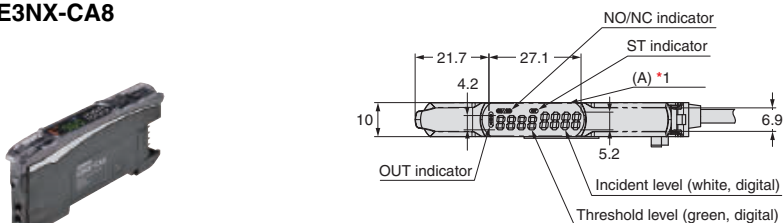

*1. The Mounting Bracket can also be used on side A.
*2. Cable Specifications

Model	Outer diameter	No. of conductors
E3X-CN12	2.6 dia.	1
E3X-CN22	4.0 dia.	2
E3X-CN11		3

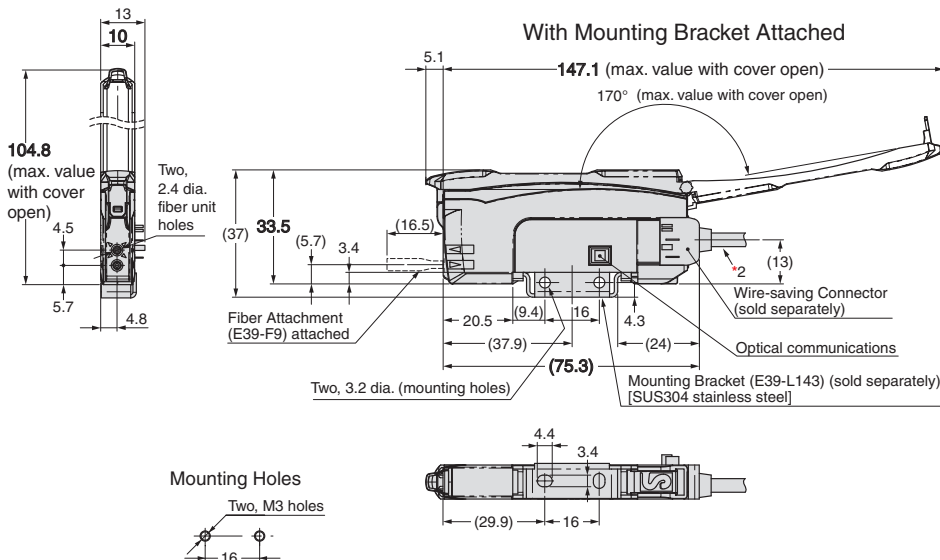

Standalone Product Diagram

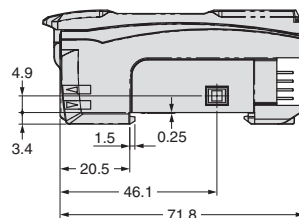

E3NX-CA

Amplifier Unit with Connector for Sensor Communications Unit E3NX-CA0

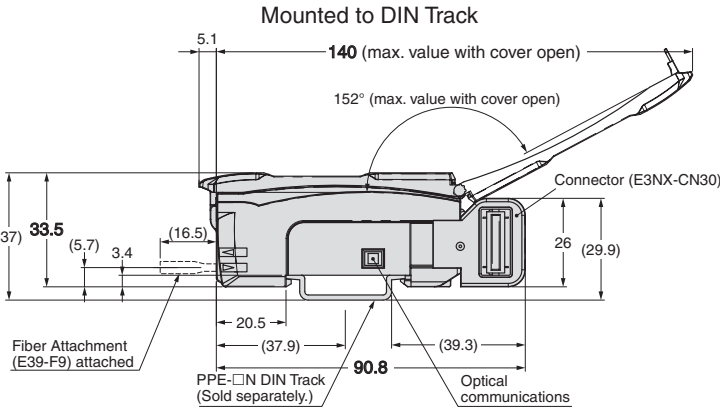
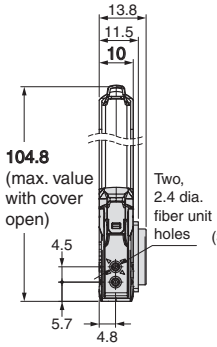
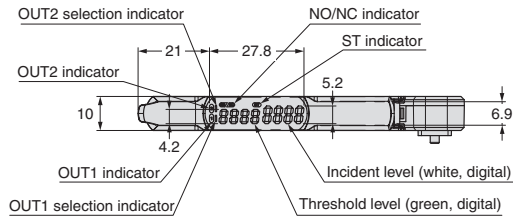

Standalone Product Diagram

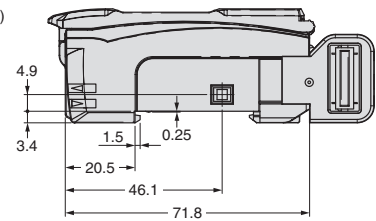

Fiber Units

Reflective Models E32-C91N

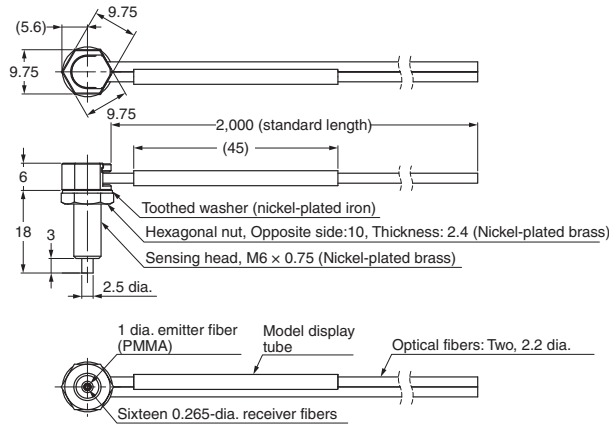

Through-beam Models (Grooved Type) E32-G16

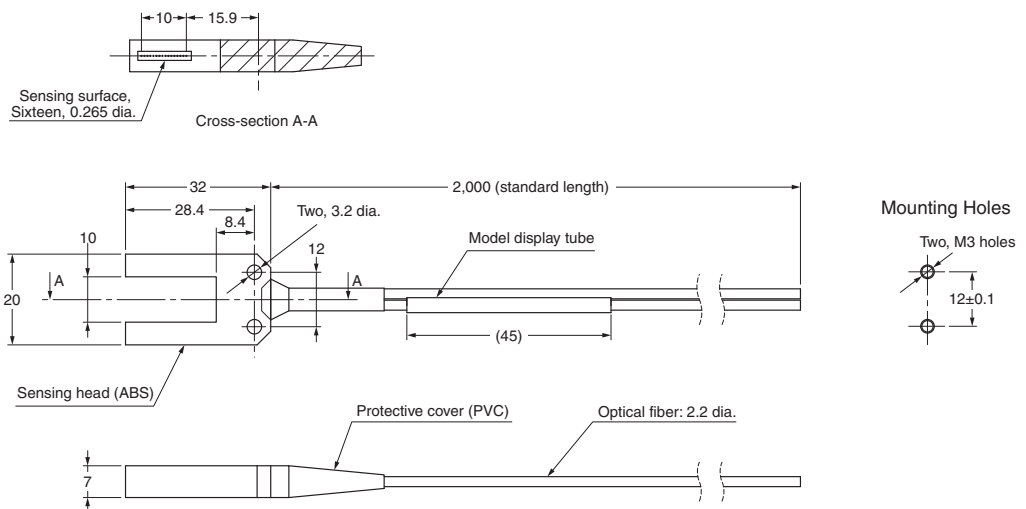

Accessories (Sold Separately)

Wire-saving Connectors

Master Connector

E3X-CN11

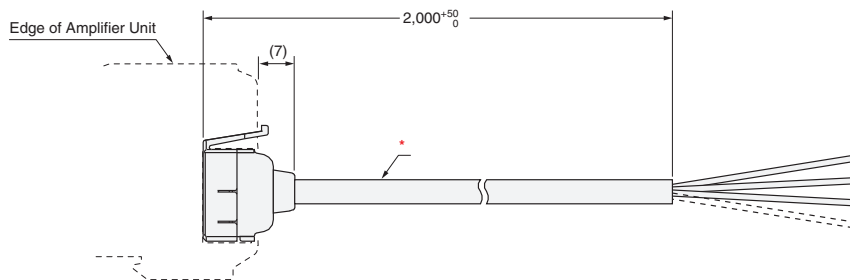

* 4-dia. cable with 3 conductors, Standard cable length: 2 m (Conductor cross-section: 0.2 mm² (AWG24), Insulator diameter: 1.1 mm)

Slave Connector

E3X-CN12

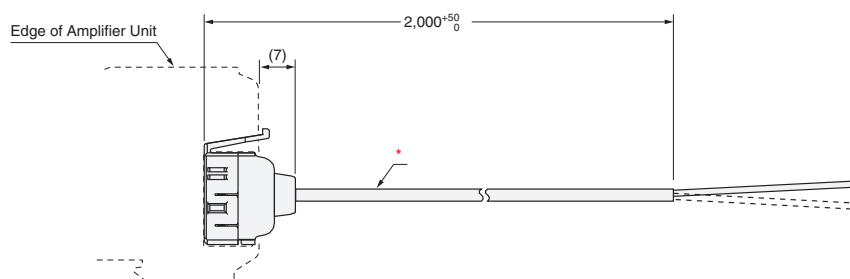

* 2.6-dia. cable with 1 conductor, Standard cable length: 2 m (Conductor cross-section: 0.2 mm² (AWG24), Insulator diameter: 1.1 mm)

Mounting Bracket

E39-L143

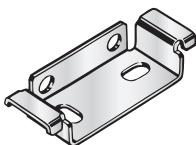

Material: Stainless steel (SUS304)

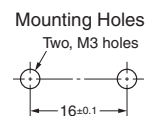
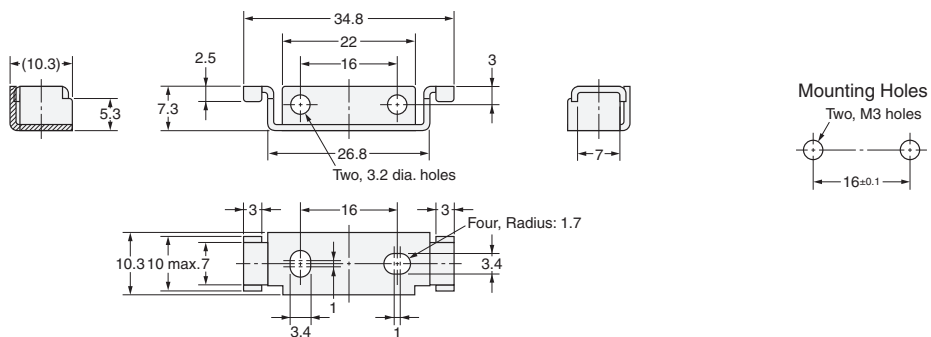

E3NX-CA

DIN Tracks

PFP-100N

PFP-50N

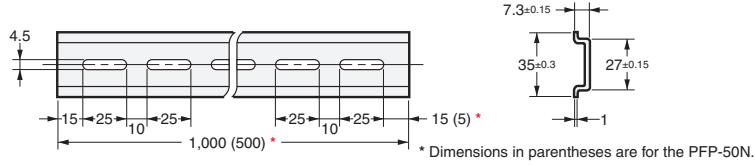

Material: Aluminum

PFP-100N2

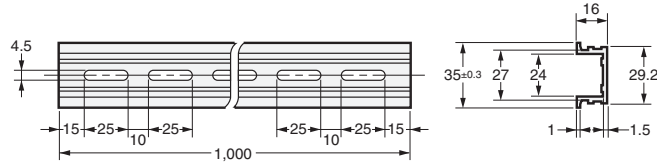

Material: Aluminum

End Plate

PFP-M

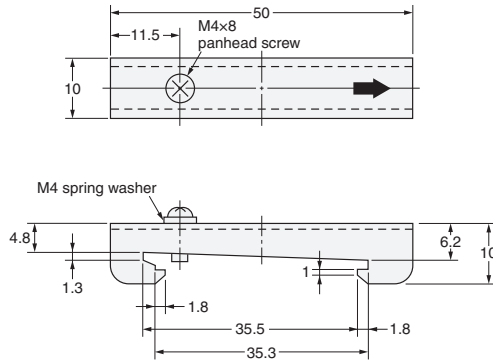

Materials: Iron, zinc plating

OMRON Corporation Industrial Automation Company

Tokyo, JAPAN

Contact: industrial.omron.eu

Regional Headquarters

OMRON EUROPE B.V.

Sensor Business Unit

Carl-Benz-Str. 4, D-71154 Nufringen, Germany
Tel: (49) 7032-811-0/Fax: (49) 7032-811-199

OMRON ASIA PACIFIC PTE. LTD.

No. 438A Alexandra Road # 05-05/08 (Lobby 2),
Alexandra Technopark,
Singapore 119967
Tel: (65) 6835-3011/Fax: (65) 6835-2711

OMRON ELECTRONICS LLC

2895 Greenspoint Parkway, Suite 200
Hoffman Estates, IL 60169 U.S.A
Tel: (1) 847-843-7900/Fax: (1) 847-843-7787

OMRON (CHINA) CO., LTD.

Room 2211, Bank of China Tower,
200 Yin Cheng Zhong Road,
PuDong New Area, Shanghai, 200120, China
Tel: (86) 21-5037-2222/Fax: (86) 21-5037-2200

Authorized Distributor:

© OMRON Corporation 2016 All Rights Reserved.
In the interest of product improvement,
specifications are subject to change without notice.

Cat. No. E105E-EN-01