

Technical data sheet

Ultrasonic sensor

Part no.: 50149548

HTU230-6000/L4-M12

Contents

- Technical data
- Dimensioned drawings
- Electrical connection
- Diagrams
- Operation and display
- Part number code
- Notes
- Accessories



For illustration purposes only



Technical data

Basic data

Series	200
Operating principle	Diffuse reflection principle with background suppression
Contains	2x M30 mounting nut

Special version

Special version	Multiplex operation
	Synchronous operation

Characteristic parameters

MTTF	633 years
------	-----------

Ultrasonic specifications

Operating range	0.6 ... 6 m
Operating range	Guaranteed operating range
Ultrasonic frequency	80 kHz
Shape of sound lobe	standard
Direction of beam	Front
Opening angle	14 °
Adjustment range	600 ... 6,000 mm

Measurement data

Resolution	1.0 mm
Repeatability	0.3 %
Reference value repeatability	End value
Temperature drift, relative	0.2 %/K

Electrical data

Protective circuit	Polarity reversal protection
	Short circuit protected

Performance data

Supply voltage U_B	18 ... 30 V, DC
Residual ripple	0 ... 10 %, From U_B
Open-circuit current	0 ... 45 mA
Switching hysteresis	20 mm

Outputs

Number of digital switching outputs	2 Piece(s)
-------------------------------------	------------

Switching outputs

Voltage type	DC
Switching current, max.	100 mA

Switching output 1

Switching element	Transistor, Push-pull
Switching principle	IO-Link / light switching (PNP)/dark switching (NPN)

Switching output 2

Switching element	Transistor, PNP
Switching principle	Light switching

Time behavior

Switching frequency	2 Hz
Response time	250 ms
Readiness delay	300 ms

Interface

Type	IO-Link
IO-Link	
COM mode	COM2
Min. cycle time	COM2 = 2.3 ms
Frame type	2.2
Specification	V1.1
Device ID	3071
SIO-mode support	Yes

Connection

Number of connections	1 Piece(s)
-----------------------	------------

Connection 1

Function	Signal OUT
	Teach input
	Voltage supply
Type of connection	Connector
Thread size	M12
Type	Male
Material	Metal
No. of pins	4 -pin
Encoding	A-coded

Mechanical data

Design	Cylindrical
Thread size	M30 x 1.5 mm
Dimension (Ø x L)	45.5 mm x 78 mm
Housing material	Metal
Metal housing	Nickel-plated brass
Ultrasonic transducer material	Piezoceramics (contains lead zirconium titanate (PZT))
Net weight	190 g
Housing color	Silver

Operation and display

Type of display	LED
Number of LEDs	1 Piece(s)

Environmental data

Ambient temperature, operation	-25 ... 70 °C
Ambient temperature, storage	-25 ... 70 °C

Certifications

Degree of protection	IP 67
Protection class	III
Certifications	c UL US
Standards applied	IEC 60947-5-2

Technical data

Customs tariff number	85365019
ECLASS 5.1.4	27272803
ECLASS 8.0	27272803
ECLASS 9.0	27272803
ECLASS 10.0	27272803
ECLASS 11.0	27272803
ECLASS 12.0	27272803
ECLASS 13.0	27272803
ETIM 5.0	EC001849
ETIM 6.0	EC001849
ETIM 7.0	EC001849
ETIM 8.0	EC001849

Dimensioned drawings

All dimensions in millimeters

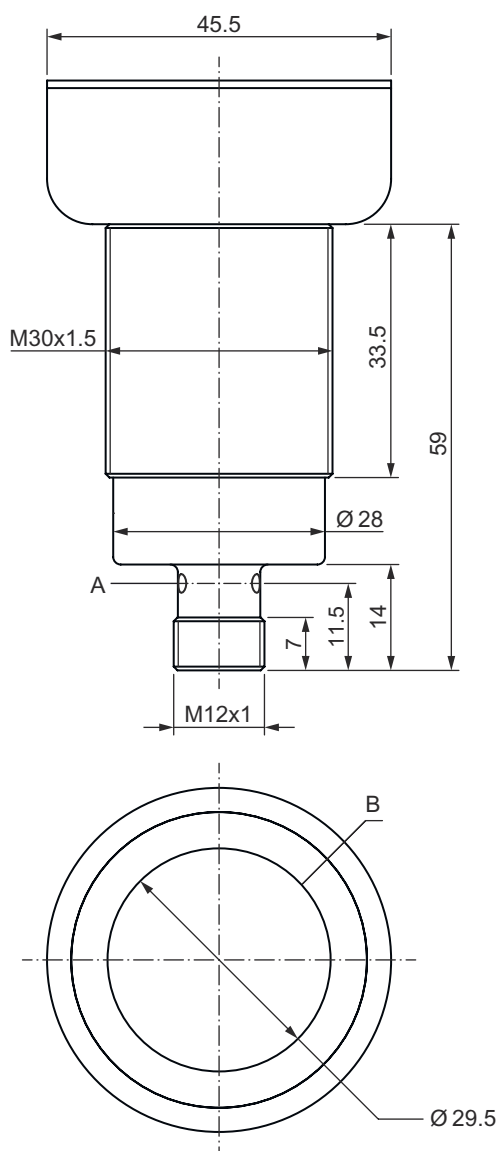

- A Indicator diode
- B Sound exit of ultrasonic transducer

Electrical connection

Connection 1

Function	Signal OUT
	Teach input
	Voltage supply
Type of connection	Connector
Thread size	M12
Type	Male
Material	Metal
No. of pins	4 -pin
Encoding	A-coded

Pin	Pin assignment
1	V+
2	IN 1
3	GND
4	IO-Link / OUT 1

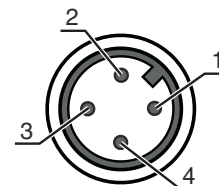

Diagrams

Typ. response behavior

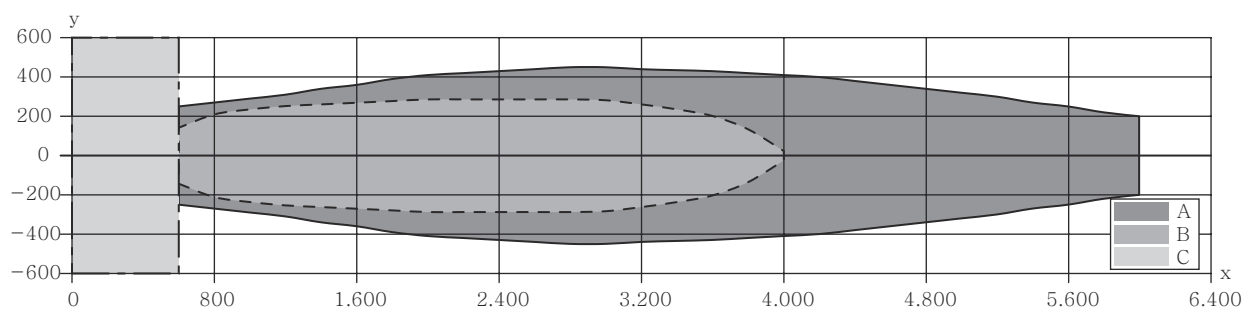

- x Object distance [mm]
- y Sound cone width [mm]
- A Plate 200 x 200 mm
- B Rod Ø 25 mm
- C Minimum distance in mm

Operation and display

LED	Display	Meaning
1	Green, continuous light	Operational readiness
	Green, flashing	IO-Link communication
	Yellow, continuous light	Switching output/switching state

Part number code

Part designation: **AAA2BB-xxxx/CD-EE**

AAA	Operating principle HTU: Ultrasonic sensor, scanning principle, with background suppression DMU: Ultrasonic sensor, distance measurement
------------	---

Part number code

2BB	Design 208: Cylindrical with M8 thread 212: Cylindrical with M12 thread 218: Cylindrical with M18 thread 230: Cylindrical with M30 thread
xxxx	Operating range Operating range in millimeters
C	Switching output / function OUT 1/IN: Pin 4 2: NPN transistor output, light switching N: NPN transistor output, dark switching 4: PNP transistor output, light switching P: PNP transistor output, dark switching L: IO-Link
D	Switching output / function OUT 2/IN: pin 2 T: teach-in via cable
EE	Electrical connection M8: M8 connector, 4-pin (plug) M12: M12 connector, 4-pin (plug)

Note



A list with all available device types can be found on the Leuze website at www.leuze.com.

Notes



Observe intended use!



- ⌘ This product is not a safety sensor and is not intended as personnel protection.
- ⌘ The product may only be put into operation by competent persons.
- ⌘ Only use the product in accordance with its intended use.



Accessories

Connection technology - Connection unit

	Part no.	Designation	Article	Description
	50144900	MD 798i-11-82/L5-2222	Distribution box	Type: IO-Link master Current consumption, max.: 11,000 mA Switching outputs for each sensor connection: 1 Piece(s) Switching output: Transistor, PNP Interface: IO-Link, Automatic protocol detection, EtherNet IP, Modbus TCP, PROFINET Connections: 12 Piece(s) Sensor connections: 8 Piece(s) Connections for voltage supply: 2 Piece(s) Interface connections: 2 Piece(s) Degree of protection: IP 67, IP 65, IP 69K

Accessories

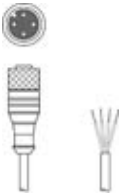
Connection technology - Connection cables

	Part no.	Designation	Article	Description
	50130652	KD U-M12-4A-V1-050	Connection cable	Connection 1: Connector, M12, Axial, Female, A-coded, 4 -pin Connector, LED: No Connection 2: Open end Shielded: No Cable length: 5.000 mm Sheathing material: PVC
	50130690	KD U-M12-4W-V1-050	Connection cable	Connection 1: Connector, M12, Angled, Female, A-coded, 4 -pin Connector, LED: No Connection 2: Open end Shielded: No Cable length: 5.000 mm Sheathing material: PVC

Mounting technology - Mounting brackets

	Part no.	Designation	Article	Description
	50113510	BT D30M.5	Mounting bracket	Diameter, inner: 30.2 mm Design of mounting device: Angle, L-shape Fastening, at system: Through-hole mounting Mounting bracket, at device: Screw type Type of mounting device: Rigid Material: Stainless steel

Mounting technology - Rod mounts

	Part no.	Designation	Article	Description
	50111503	MC 030K	Clamp	Diameter, inner: 30 mm Design of mounting device: Mounting clamp Fastening, at system: Through-hole mounting Mounting bracket, at device: Clampable Type of mounting device: Rigid Material: Plastic

Note



A list with all available accessories can be found on the Leuze website in the Download tab of the article detailed page.