

Technical data sheet

Throughbeam photoelectric sensor receiver

Part no.: 50140156

LE412B/2X-M12

Contents

- Technical data
- Dimensioned drawings
- Electrical connection
- Operation and display
- Suitable transmitters
- Part number code
- Notes
- Accessories



For illustration purposes only



Technical data

Basic data

Series	412B
Operating principle	Throughbeam principle
Device type	Receiver

Optical data

Operating range	0 ... 10 m
Operating range	Guaranteed operating range
Operating range limit	Typical operating range
Operating range limit	0 ... 10 m

Electrical data

Protective circuit	Polarity reversal protection Short circuit protected
--------------------	---

Performance data

Supply voltage U_B	10 ... 36 V, DC, Incl. residual ripple
Residual ripple	0 ... 20 %, From U_B
Open-circuit current	0 ... 15 mA

Outputs

Number of digital switching outputs	1 Piece(s)
-------------------------------------	------------

Switching outputs

Voltage type	DC
Switching current, max.	200 mA

Switching output 1

Assignment	Connection 1, pin 2
Switching element	Transistor, NPN
Switching principle	Light switching

Time behavior

Switching frequency	1,000 Hz
Response time	0.5 ms
Readiness delay	20 ms

Connection

Connection 1

Function	Signal OUT Voltage supply
Type of connection	Connector
Thread size	M12
Type	Male
Material	Metal
No. of pins	4 -pin
Encoding	A-coded

Mechanical data

Thread size	M12 x 1 mm
Dimension (Ø x L)	12 mm x 60 mm
Housing material	Metal
Metal housing	Chromed brass
Lens cover material	Glass
Net weight	32 g
Housing color	Silver

Operation and display

Type of display	LED
Number of LEDs	2 Piece(s)

Environmental data

Ambient temperature, operation	-25 ... 55 °C
--------------------------------	---------------

Certifications

Degree of protection	IP 67
Protection class	III
Certifications	c UL US
Standards applied	IEC 60947-5-2

Classification

Customs tariff number	85365019
ECLASS 5.1.4	27270901
ECLASS 8.0	27270901
ECLASS 9.0	27270901
ECLASS 10.0	27270901
ECLASS 11.0	27270901
ECLASS 12.0	27270901
ECLASS 13.0	27270901
ECLASS 14.0	27270901
ETIM 5.0	EC002716
ETIM 6.0	EC002716
ETIM 7.0	EC002716
ETIM 8.0	EC002716
ETIM 9.0	EC002716

Dimensioned drawings

All dimensions in millimeters

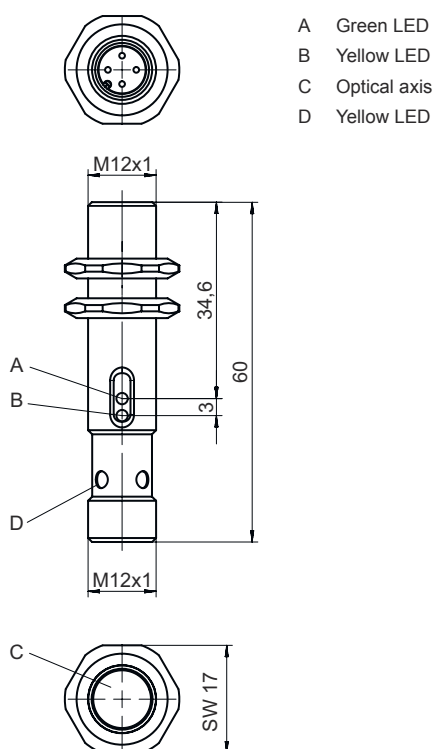

Electrical connection

Connection 1

Function	Signal OUT Voltage supply
Type of connection	Connector
Thread size	M12
Type	Male
Material	Metal
No. of pins	4 -pin
Encoding	A-coded

Pin Pin assignment

Pin	Pin assignment
1	V+
2	OUT 1
3	GND
4	n.c.

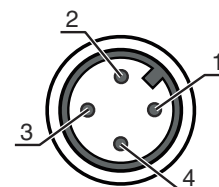

Operation and display

LED	Display	Meaning
1	Green, continuous light	Function reserve
2	Yellow, continuous light	Switching output/switching state active

Suitable transmitters

	Part no.	Designation	Article	Description
	50140150	LS412B/DX-M12	Throughbeam photoelectric sensor transmitter	Special version: Deactivation input Operating range limit: 0 ... 10 m Light source: LED, Red Supply voltage: DC Deactivation inputs: 1 Piece(s) Connection: Connector, M12, Metal, 4 -pin

Part number code

Part designation: AAA412BGG.H/ii-K

AAA412B	Operating principle / construction LS412B: Throughbeam photoelectric sensor transmitter LE412B: Throughbeam photoelectric sensor receiver ET412B: Energetic diffuse reflection sensor PRK412B: Retro-reflective photoelectric sensor with polarization filter
GG	Light source n/a: LED L2: laser class 2
H	Operating range adjustment 1: 270° potentiometer
ii	Switching output / function / OUT1OUT2 (OUT1 = pin 2, OUT2 = pin 4) 2: NPN transistor output, light switching N: NPN transistor output, dark switching 4: PNP transistor output, light switching P: PNP transistor output, dark switching D: Deactivation input (deactivation with low signal) X: pin not used
K	Electrical connection n/a: cable, standard length 2000 mm, 3-wire M12: M12 connector, 4-pin (plug)

Note



A list with all available device types can be found on the Leuze website at www.leuze.com.

Notes





Observe intended use!



- ⌘ This product is not a safety sensor and is not intended as personnel protection.
- ⌘ The product may only be put into operation by competent persons.
- ⌘ Only use the product in accordance with its intended use.

Accessories

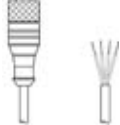
Connection technology - Connection cables

	Part no.	Designation	Article	Description
 	50130652	KD U-M12-4A-V1-050	Connection cable	Connection 1: Connector, M12, Axial, Female, A-coded, 4 -pin Connector, LED: No Connection 2: Open end Shielded: No Cable length: 5.000 mm Sheathing material: PVC
 	50130690	KD U-M12-4W-V1-050	Connection cable	Connection 1: Connector, M12, Angled, Female, A-coded, 4 -pin Connector, LED: No Connection 2: Open end Shielded: No Cable length: 5.000 mm Sheathing material: PVC

Mounting technology - Mounting brackets

	Part no.	Designation	Article	Description
	50113549	BT D12M.5	Mounting bracket	Diameter, inner: 12 mm Design of mounting device: Angle, L-shape Fastening, at system: Through-hole mounting Mounting bracket, at device: Screw type Type of mounting device: Rigid Material: Stainless steel

Note



A list with all available accessories can be found on the Leuze website in the Download tab of the article detailed page.