

Technical data sheet

Polarized retro-reflective photoelectric sensor

Part no.: 50136259

PRK3C.T3/2T



For illustration purposes only

Contents

- Technical data
- Dimensioned drawings
- Electrical connection
- Diagrams
- Operation and display
- Reflectors & reflective tapes
- Part number code
- Notes
- Further information
- Accessories



Technical data

Basic data

Series	3C
Operating principle	Reflection principle
Application	Detection of highly transparent bottles Detection of transparent films

Special version

Special version	Autocollimation
-----------------	-----------------

Optical data

Operating range	0 ... 3 m
Operating range	Guaranteed operating range
Reference reflector	With reflector TK(S) 100x100
Operating range limit	Typical operating range
Operating range limit	0 ... 3.6 m, With reflector TK(S) 100x100
Light source	LED, Red
Wavelength	635 nm
Transmitted-signal shape	Pulsed
LED group	Exempt group (in acc. with EN 62471)

Electrical data

Protective circuit	Polarity reversal protection Short circuit protected
--------------------	---

Performance data

Supply voltage U_B	10 ... 30 V, DC, Incl. residual ripple
Residual ripple	0 ... 15 %, From U_B
Open-circuit current	0 ... 15 mA

Inputs

Number of teach inputs	1 Piece(s)
------------------------	------------

Teach inputs

Voltage type	DC
Switching voltage	high: $\geq 0.65 \times U_B$ low: $\leq 0.35 \times U_B$
Delay	1 ms
Input resistance	20,000 Ω

Teach input 1

Function	Keyboard lockout Light/dark switching Sensitivity adjustment
Active switching state	High

Outputs

Number of digital switching outputs	1 Piece(s)
-------------------------------------	------------

Switching outputs

Voltage type	DC
Switching current, max.	100 mA
Switching voltage	high: $\geq (U_B - 2V)$ low: $\leq 2 V$

Switching output 1

Switching element	Transistor, NPN
Switching principle	Light switching

Time behavior

Switching frequency	1,500 Hz
Response time	0.33 ms
Readiness delay	300 ms
Response jitter	110 μ s

Connection

Connection 1

Function	Signal IN Signal OUT Voltage supply
Type of connection	Cable
Cable length	2,000 mm
Sheathing material	PUR
Cable color	Black
Number of conductors	4 -wire
Wire cross section	0.2 mm ²

Mechanical data

Dimension (W x H x L)	11.4 mm x 34.2 mm x 18.3 mm
Housing material	Plastic
Plastic housing	PC-ABS
Lens cover material	Plastic / PMMA
Net weight	50 g
Housing color	Red
Type of fastening	Through-hole mounting Via optional mounting device
Compatibility of materials	ECOLAB

Operation and display

Type of display	LED
Number of LEDs	2 Piece(s)
Operational controls	Teach button
Function of the operational control	Sensitivity adjustment

Environmental data

Ambient temperature, operation	-40 ... 60 °C
Ambient temperature, storage	-40 ... 70 °C

Certifications

Degree of protection	IP 67 IP 69K
Protection class	III
Certifications	c UL US
Standards applied	IEC 60947-5-2

Technical data

Customs tariff number	85365019
ECLASS 5.1.4	27270902
ECLASS 8.0	27270902
ECLASS 9.0	27270902
ECLASS 10.0	27270902
ECLASS 11.0	27270902
ECLASS 12.0	27270902
ECLASS 13.0	27270902
ECLASS 14.0	27270902
ETIM 5.0	EC002717
ETIM 6.0	EC002717
ETIM 7.0	EC002717
ETIM 8.0	EC002717
ETIM 9.0	EC002717

Dimensioned drawings

All dimensions in millimeters

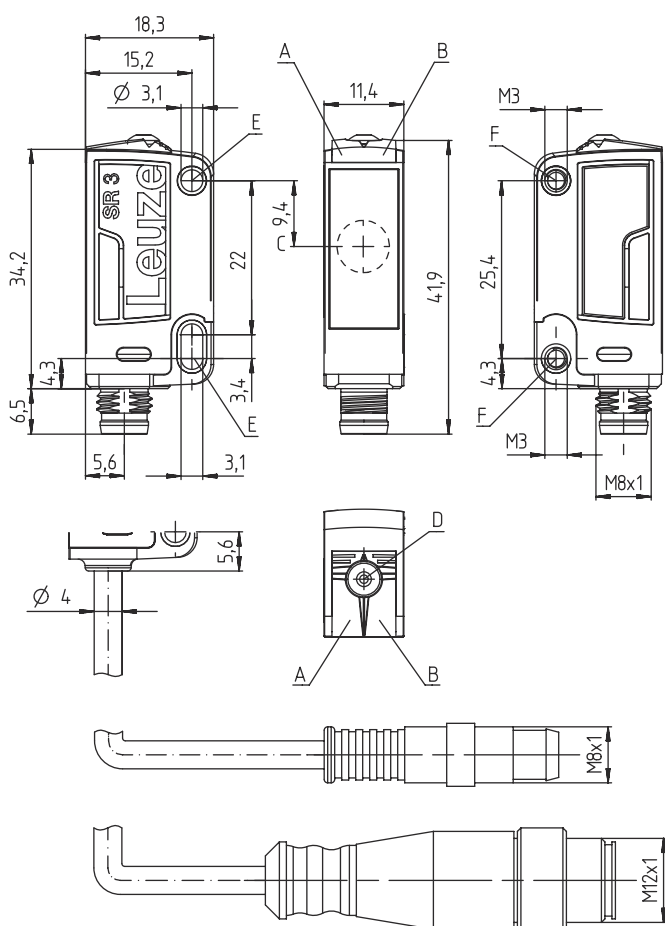

- A Green LED
- B Yellow LED
- C Optical axis
- D Teach button
- E Mounting sleeve (standard)
- F Threaded sleeve (3C.B series)

Electrical connection

Connection 1

Function	Signal IN
	Signal OUT
	Voltage supply
Type of connection	Cable
Cable length	2,000 mm
Sheathing material	PUR
Cable color	Black
Number of conductors	4 -wire
Wire cross section	0.2 mm ²

Conductor color

Conductor assignment

Brown	V+
White	Teach-in
Blue	GND
Black	OUT 1

Diagrams

Typ. response behavior

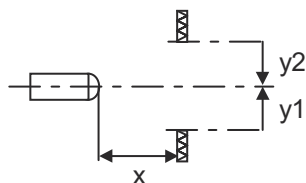
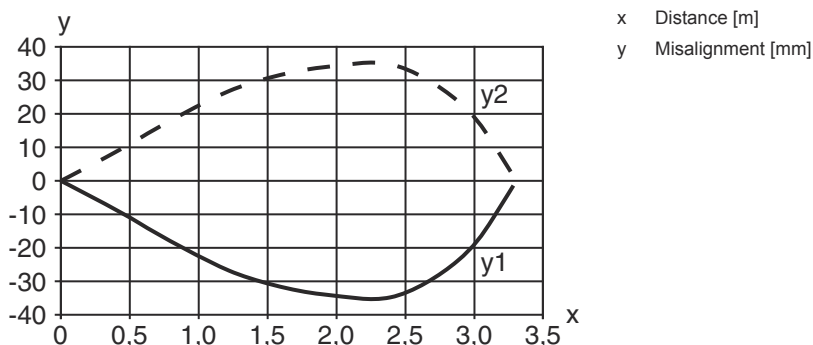



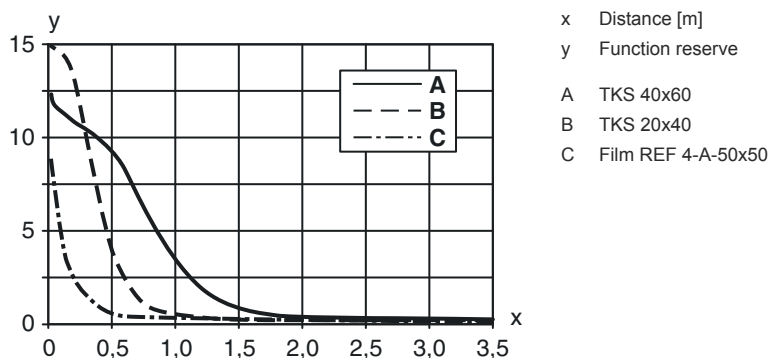



Typ. function reserve



Operation and display

LED	Display	Meaning
1	Green, continuous light	Operational readiness
2	Yellow, continuous light	Light path free

Reflectors & reflective tapes

	Part no.	Designation	Operating range Operating range limit	Description
	50117583	MTKS 50x50.1	0 ... 1.3 m 0 ... 1.6 m	Design: Rectangular Triple reflector size: 1.2 mm Reflective surface: 50 mm x 50 mm Material: Plastic Base material: Plastic Chemical designation of the material: PMMA8N Fastening: Through-hole mounting, Adhesive
	50110192	REF 6-A-50x50	0 ... 1.2 m 0 ... 1.4 m	Design: Rectangular Triple reflector size: 0.3 mm Reflective surface: 50 mm x 50 mm Material: Plastic Chemical designation of the material: PMMA Fastening: Self-adhesive
	50003192	TK 100x100	0 ... 3 m 0 ... 3.6 m	Design: Rectangular Triple reflector size: 4 mm Reflective surface: 96 mm x 96 mm Material: Plastic Base material: Plastic Chemical designation of the material: PMMA8N Fastening: Rear side can be glued
	50022816	TKS 100X100	0 ... 3 m 0 ... 3.6 m	Design: Rectangular Triple reflector size: 4 mm Reflective surface: 96 mm x 96 mm Material: Plastic Base material: Plastic Chemical designation of the material: PMMA8N Fastening: Through-hole mounting, Adhesive
	50081283	TKS 20X40	0 ... 1 m 0 ... 1.2 m	Design: Rectangular Triple reflector size: 2.3 mm Reflective surface: 16 mm x 38 mm Material: Plastic Base material: Plastic Chemical designation of the material: PMMA8N Fastening: Through-hole mounting, Adhesive
	50040820	TKS 40X60	0 ... 2 m 0 ... 2.4 m	Design: Rectangular Triple reflector size: 4 mm Reflective surface: 37 mm x 56 mm Material: Plastic Base material: Plastic Chemical designation of the material: PMMA8N Fastening: Through-hole mounting, Adhesive

Part number code

Part designation: AAA 3C d EE-f.GG H/i J-K

AAA3C

Operating principle / construction

HT3C: Diffuse reflection sensor with background suppression
 LS3C: Throughbeam photoelectric sensor transmitter
 LE3C: Throughbeam photoelectric sensor receiver
 PRK3C: Retro-reflective photoelectric sensor with polarization filter
 ODT3C: Distance diffuse sensor with background suppression

Part number code

d	Light type n/a: red light l: infrared light
EE	Light source n/a: LED L1: laser class 1 L2: laser class 2
f	Preset range (optional) n/a: operating range acc. to data sheet xxxF: Preset range [mm] 2M: operating range of 2 meters
GG	Equipment n/a: standard A: Autocollimation principle (single lens) for positioning tasks B: Housing model with two M3 threaded sleeves, brass F: Permanently set range L: Long light spot S: small light spot T: autocollimation principle (single lens) for highly transparent bottles without tracking TT: autocollimation principle (single lens) for highly transparent bottles with tracking V: V-optics XL: Extra long light spot X: extended model HF: Suppression of HF illumination (LED)
H	Operating range adjustment n/a with HT: range adjustable via 8-turn potentiometer n/a with retro-reflective photoelectric sensors (PRK): operating range not adjustable 1: 270° potentiometer 3: teach-in via button 6: auto-teach
i	Switching output/function OUT 1/IN: Pin 4 or black conductor 2: NPN transistor output, light switching N: NPN transistor output, dark switching 4: PNP transistor output, light switching P: PNP transistor output, dark switching 6: push-pull switching output, PNP light switching, NPN dark switching G: Push-pull switching output, PNP dark switching, NPN light switching L: IO-Link interface (SIO mode: PNP light switching, NPN dark switching) 8: activation input (activation with high signal) X: pin not used 1: IO-Link / light switching (NPN) / dark switching (PNP)
J	Switching output / function OUT 2/IN: pin 2 or white conductor 2: NPN transistor output, light switching N: NPN transistor output, dark switching 4: PNP transistor output, light switching P: PNP transistor output, dark switching 6: push-pull switching output, PNP light switching, NPN dark switching G: Push-pull switching output, PNP dark switching, NPN light switching W: warning output X: pin not used 8: activation input (activation with high signal) 9: deactivation input (deactivation with high signal) T: teach-in via cable
K	Electrical connection n/a: cable, standard length 2000 mm, 4-wire 5000: cable, standard length 5000 mm, 4-wire M8: M8 connector, 4-pin (plug) M8.3: M8 connector, 3-pin (plug) 200-M8: cable, length 200 mm with M8 connector, 4-pin, axial (plug) 200-M8.3: cable, length 200 mm with M8 connector, 3-pin, axial (plug) 200-M12: cable, length 200 mm with M12 connector, 4-pin, axial (plug)

Note



A list with all available device types can be found on the Leuze website at www.leuze.com.

Notes



Observe intended use!



- ⚠ This product is not a safety sensor and is not intended as personnel protection.
- ⚠ The product may only be put into operation by competent persons.
- ⚠ Only use the product in accordance with its intended use.

For UL applications:



- ⓘ For UL applications, use is only permitted in Class 2 circuits in accordance with the NEC (National Electric Code).
- ⓘ These proximity switches shall be used with UL Listed Cable assemblies rated 30V, 0.5A min, in the field installation, or equivalent (categories: CYJV/ CYJV7 or PVVA/PVVA7)

Further information

- Light source: Average life expectancy 100,000 h at an ambient temperature of 25 °C
- Response time: For short decay times, an ohmic load of approx. 5kOhm is recommended
- Sum of the output currents for both outputs, 50 mA for ambient temperatures > 40 °C
- The light spot may not exceed the reflector.
- Use of micro-triad-type reflectors beginning with MTK(S) or REF 6-A- reflective tape is preferred.
- For REF 6-A- reflective tape, the sensor's side edge must be aligned parallel to the side edge of the reflective tape.

Accessories

Mounting technology - Mounting brackets

	Part no.	Designation	Article	Description
	50060511	BT 3	Mounting device	Design of mounting device: Angle, L-shape Fastening, at system: Through-hole mounting Mounting bracket, at device: Screw type Type of mounting device: Rigid Material: Metal

Mounting technology - Rod mounts

	Part no.	Designation	Article	Description
	50117255	BTU 200M-D12	Mounting system	Design of mounting device: Mounting system Fastening, at system: For 12 mm rod, Sheet-metal mounting Mounting bracket, at device: Screw type, Suited for M3 screws Type of mounting device: Clampable, Adjustable, Turning, 360° Material: Metal

Accessories

Micro-triad-type reflectors

	Part no.	Designation	Article	Description
	50117583	MTKS 50x50.1	Reflector	Design: Rectangular Triple reflector size: 1.2 mm Reflective surface: 50 mm x 50 mm Material: Plastic Base material: Plastic Chemical designation of the material: PMMA8N Fastening: Through-hole mounting, Adhesive

Reflective tapes for laser and clear-glass applications

	Part no.	Designation	Article	Description
	50109257	TKS 40x60.1	Reflector	Design: Rectangular Triple reflector size: 2.3 mm Reflective surface: 37 mm x 56 mm Material: Plastic Base material: Plastic Chemical designation of the material: PMMA8N Fastening: Through-hole mounting, Adhesive

Note



A list with all available accessories can be found on the Leuze website in the Download tab of the article detailed page.