

Technical data sheet

Inductive switch

Part no.: 50136011

ISS 118MM/4NO-8E0

Contents

- Technical data
- Dimensioned drawings
- Electrical connection
- Diagrams
- Operation and display
- Part number code
- Notes
- Accessories



Figure can vary



Technical data

Basic data

Series	118
Typ. operating range limit S_n	8 mm
Operating range S_a	0 ... 6.48 mm

Electrical data

Protective circuit	Overload protection
	Polarity reversal protection
	Short circuit protected

Performance data

Supply voltage U_B	10 ... 30 V, DC
Residual ripple	0 ... 10 %, From U_B
Open-circuit current	0 ... 10 mA
Temperature drift, max. (in % of S_r)	10 %
Repeatability, max. (in % of S_r)	1 %
Switching hysteresis	15 %

Outputs

Number of digital switching outputs	1 Piece(s)
-------------------------------------	------------

Switching outputs

Voltage type	DC
Switching current, max.	200 mA
Residual current, max.	0.01 mA
Voltage drop	≤ 2 V

Switching output 1

Switching element	Transistor, PNP
Switching principle	NO (normally open)

Time behavior

Switching frequency	3,000 Hz
Readiness delay	25 ms

Connection

Number of connections	1 Piece(s)
-----------------------	------------

Connection 1

Function	Signal OUT
	Voltage supply
Type of connection	Cable
Cable length	2,000 mm
Sheathing material	PVC
Cable color	Black
Number of conductors	3 -wire
Wire cross section	0.35 mm ²

Mechanical data

Design	Cylindrical
Thread size	M18 x 1 mm
Dimension (Ø x L)	18 mm x 40 mm
Type of installation	Embedded
Housing material	Metal
Metal housing	Nickel-plated brass
Sensing face material	Plastic, Polybutylene (PBT)
Housing color	Red, RAL 3000
	Silver
Type of fastening	Mounting thread
Standard measuring plate	24 x 24 mm ² , Fe360

Operation and display

Type of display	LED
Number of LEDs	1 Piece(s)

Environmental data

Ambient temperature, operation	-25 ... 70 °C
Ambient temperature, storage	-25 ... 70 °C

Certifications

Degree of protection	IP 67
Standards applied	IEC 60947-5-2

Correction factors

Fe360 steel	1
Stainless steel	0.6 ... 1
Brass	0.35 ... 0.5
Aluminum	0.35 ... 0.45
Copper	0.25 ... 0.45

Classification

Customs tariff number	85365019
ECLASS 5.1.4	27270101
ECLASS 8.0	27270101
ECLASS 9.0	27270101
ECLASS 10.0	27270101
ECLASS 11.0	27270101
ECLASS 12.0	27274001
ECLASS 13.0	27274001
ETIM 5.0	EC002714
ETIM 6.0	EC002714
ETIM 7.0	EC002714
ETIM 8.0	EC002714

Dimensioned drawings

All dimensions in millimeters

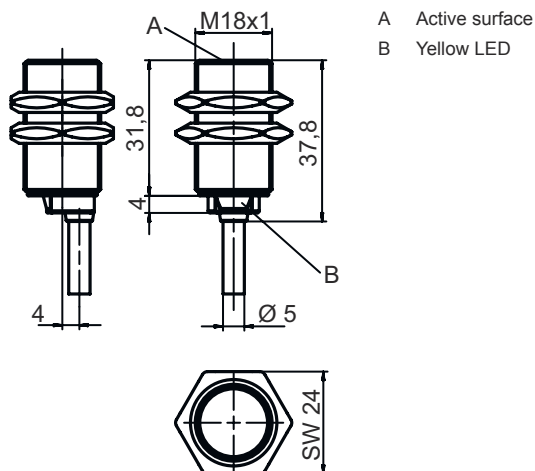

Electrical connection

Connection 1

Function	Signal OUT
	Voltage supply
Type of connection	Cable
Cable length	2,000 mm
Sheathing material	PVC
Cable color	Black
Number of conductors	3 -wire
Wire cross section	0.35 mm ²

Conductor color

Brown
Blue
Black

Conductor assignment

V+
GND
OUT 1

Diagrams

Embedded installation

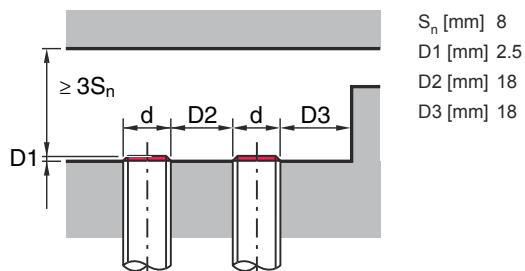

Operation and display

LED	Display	Meaning
1	Yellow, continuous light	Switching output/switching state

Part number code

Part designation: **ISX YYY XX/ZZZ-AAA-BBBB**



ISX	Operating principle / construction IS: inductive switch, standard design ISS: inductive switch, short construction
YYY	Series 104: series with Ø 4.0 mm 108: series with M8 x 1 external thread 112: series with M12 x 1 external thread 118: series with M18 x 1 external thread 122: series in cubic design with 18 x 18 mm 130: series with M30 x 1.5 external thread 144: series in cubic design with 40 x 40 mm 180: series in cubic design with 80 x 80 mm
XX	Housing MM: metal housing (active surface: plastic) / metric thread PP: Plastic housing MP: metal housing (active surface: plastic) / smooth (without thread)
ZZZ	Switching output 4NO: PNP transistor, NO contact 4NC: PNP transistor, NC contact 44: PNP transistor, NO contact / NC contact 2NO: NPN transistor, NO contact 2NC: NPN transistor, NC contact 22: NPN transistor, NO contact / NC contact
AAA	Measurement range / type of installation 1E2: typ. range limit 1.2 mm / embedded installation 2E0: typ. range limit 2.0 mm / embedded installation 4E0: typ. range limit 4.0 mm / embedded installation 4N0: typ. range limit 4.0 mm / non-embedded installation 5E0: typ. range limit 5.0 mm / embedded installation 6E0: typ. range limit 6.0 mm / embedded installation 8E0: typ. range limit 8.0 mm / embedded installation 8N0: typ. range limit 8.0 mm / non-embedded installation 10E: typ. range limit 10.0 mm / embedded installation 15N: typ. range limit 15.0 mm / non-embedded installation 16E: typ. range limit 16.0 mm / embedded installation 16N: typ. range limit 16.0 mm / non-embedded installation 20E: typ. range limit 20.0 mm / embedded installation 25N: typ. range limit 25.0 mm / non-embedded installation 30N: typ. range limit 30.0 mm / non-embedded installation 40N: typ. range limit 40.0 mm / non-embedded installation 50N: typ. range limit 50.0 mm / non-embedded installation
DDD	Electrical connection n/a: cable, standard length 2000 mm, 3-wire M8.3: M8 connector, 3-pin (plug) M12: M12 connector, 4-pin (plug) TB.4: terminals, 4-pin 050: cable, standard length 5000 mm, 3-wire

Note



A list with all available device types can be found on the Leuze website at www.leuze.com.

Notes

 Observe intended use!	
	<ul style="list-style-type: none"> ⌘ This product is not a safety sensor and is not intended as personnel protection. ⌘ The product may only be put into operation by competent persons. ⌘ Only use the product in accordance with its intended use.

Accessories

Mounting technology - Other

	Part no.	Designation	Article	Description
	50111501	MC 018K	Clamp	Diameter, inner: 18 mm Design of mounting device: Mounting clamp Fastening, at system: Through-hole mounting Mounting bracket, at device: Clampable Type of mounting device: Rigid Material: Plastic

Note	
	<ul style="list-style-type: none"> ⌘ A list with all available accessories can be found on the Leuze website in the Download tab of the article detailed page.