

CRT 20B

Colour sensors

en 02-2014/05 50109619-01



12.5mm  
60mm



- Scanner for colour detection
- Very short response time  $\geq 85\mu s$  for detection of fast or small objects and marks
- Direct indication of colour quality by means of bargraph display
- Simultaneous selection of up to 4 colours
- Teach-in via buttons or control line
- Temperature compensation for reproducible colour detection

Dimensioned drawing

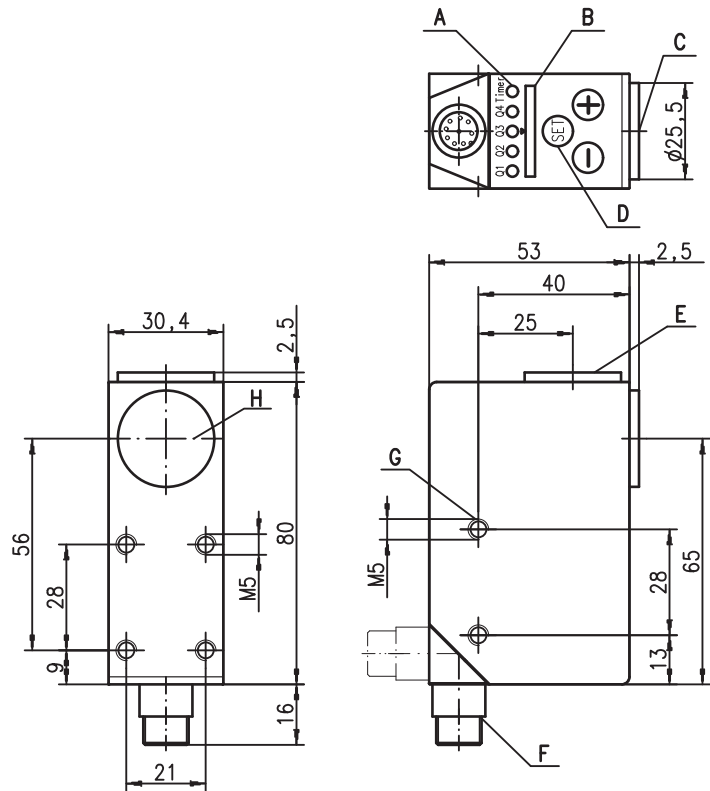

- A Function indicator (yellow)
- B Bargraph display (green), Power On = left LED
- C Dimensioned drawing of the objective
- D Teach-in button, '+' and '-' buttons
- E Dummy screw fitting, interchangeable with H
- F 90° turning connector
- G Mounting thread M5 – 5.5mm deep
- H Objective (light beam gate)

Electrical connection

CRT 20B M/P...001-S12

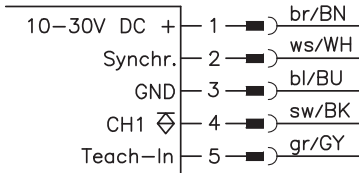

CRT 20B M/N...001-S12

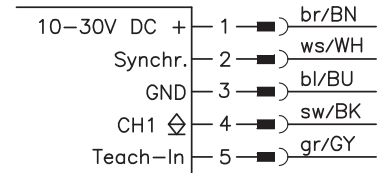

CRT 20B M/P...004-S12

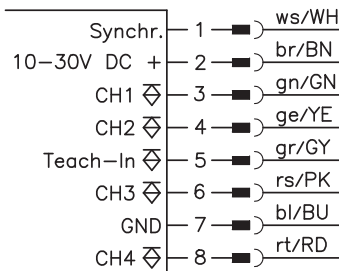

CRT 20B M/N...004-S12

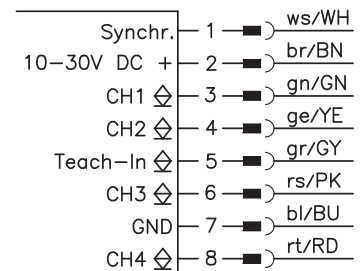

Accessories:

(available separately)

- Cable with M12 connector, 5-pin
- Cable with M12 connector, 8-pin
- Reflectors

We reserve the right to make changes • DS\_CRT20B\_en\_50109619\_01.fm



**Specifications**

**Optical data**

Scanning range (see remarks)  
 Light spot dimensions (in scanning range)  
 Operating range with reflector <sup>1)</sup>  
 Light spot orientation  
 Light source<sup>2)</sup>  
 Wavelength

**Objective 1**

12.5mm ± 3mm  
 4.0mmx2.0mm  
 100 ... 250mm  
 vertical  
 LEDs (red, green, blue)  
 640nm, 525nm, 470nm

**Objective 2**

60mm ± 9mm  
 13.0mmx13.0mm  
 250 ... 1000mm

**Timing**

Switching frequency <sup>3)</sup>  
 Response time <sup>3)</sup>  
 Delay before start-up  
 Storage time

adjustable: 1 kHz, 3kHz, 6kHz  
 adjustable: 500µs, 160µs, 85µs  
 ≤ 500ms  
 25ms, non-volatile storage

**CRT 20B...-004**

0.5kHz, 1 kHz, 3.5kHz  
 1 ms, 500µs, 145µs

**Electrical data**

Operating voltage  $U_B$  <sup>4)</sup>  
 Residual ripple<sup>5)</sup>  
 Switching output

10 ... 30VDC (incl. residual ripple)  
 ≤ 15% of  $U_B$   
 1x PNP / 1x NPN  
 (for one colour assignment)      4x PNP / 4x NPN  
 (for four colour assignments)

Function characteristics  
 Signal voltage high/low

light/dark switching for all outputs  
 PNP:  $\geq (U_B - 2V)/0V$   
 NPN:  $U_B \leq 2V$   
 max. 120mA per output  
 ≤ 80mA

Output current  
 Open-circuit current

**Indicators**

Q LED(s) - yellow  
 Timer LED - yellow  
 Bargraph display LEDs - green

Q: object 1 detected      Q1-Q4: object 1-4 detected  
 timer activated  
 left LED = Power On  
 remaining LEDs = colour value display

**Mechanical data**

Housing  
 Optics cover  
 Weight  
 Connection type

diecast zinc  
 glass  
 approx. 400g  
 M12 connector, 5-pin      M12 connector, 8-pin

**Environmental data**

Ambient temp. (operation/storage)  
 Protection class  
 Light source  
 VDE safety class <sup>6)</sup>  
 Protective circuit <sup>7)</sup>  
 Standards applied  
 Certifications

-10°C ... +55°C/-25°C ... +75°C  
 IP 67  
 free group (in accordance with EN 62471)  
 II, all-insulated  
 2, 3  
 IEC 60947-5-2  
 UL 508, C22.2 No.14-13 <sup>4) 8)</sup>

**Options**

**Teach-in input**

PNP: Teach-in / Run  
 NPN: Teach-in / Run  
 Teach duration

> 10V ... ≤  $U_B / 0V$  or not connected  
 ≤ 2V /  $U_B$  or not connected  
 > 2ms

**Synchronous input**

PNP: Stop/Start measurement  
 NPN: Stop/Start measurement  
 Synchronisation delay

> 10V ... ≤  $U_B / 0V$  or not connected  
 ≤ 2V /  $U_B$  or not connected  
 > 0,2ms

**Pulse stretching <sup>9)</sup>**

20ms, can be switched on

- 1) With reflector TKS 100x100
- 2) Average life expectancy 100,000h at an ambient temperature of 25°C
- 3) With light-dark ratio 1:1
- 4) For UL applications: for use in class 2 circuits according to NEC only
- 5) Must lie within  $U_B \pm$  tolerance
- 6) Rating voltage 50VDC
- 7) 2=polarity reversal protection, 3=short-circuit protection for all outputs
- 8) These proximity switches shall be used with UL Listed Cable assemblies rated 30V, 0.5A min, in the field installation, or equivalent (categories: CYJV/CYJV7 or PVVA/PVVA7)
- 9) Relative to object

**Remarks**

- **Intended use:**  
 The CRT 20B colour sensors are optoelectronic sensors and are used for optical, contactless detection of coloured objects with incident light (scanner operation) and transmitted light (reflector operation). A reflector is necessary for operation in transmitted light.

**Operate in accordance with intended use!**

- ⚠ This product is not a safety sensor and is not intended as personnel protection.
- ⚠ The product may only be put into operation by competent persons.
- ⚠ Only use the product in accordance with the intended use.

- With shiny objects, the sensor is to be mounted at an angle of approx. 10 ... 30° to the object surface.

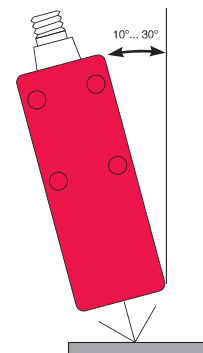

**Order guide**

See section **Preferred types**

**Function principle of the colour sensor**

Many sensors are capable of differentiating between light and dark or matt and shiny. As soon as colour is to serve as a distinguishing criterion, however, normal sensors are quickly pushed to their limits.

As a result, colour sensors are of increasing importance in industrial automation.

The applications range from sorting coloured objects to the detection or inspection of coloured surfaces. Materials such as powders, granulates, fluids as well as metals, glasses, papers, plastics and textiles can be reliably detected in this way.

Simple operation makes it possible to teach-in the reference colour and to adjust the tolerance range.

During operation, the colour sensor compares the taught-in colour with the measured colour. If the values lie within the set tolerance range, the sensor passes on the match to the controller via a switching output.

**Controls and indicators**

CRT 20B...001

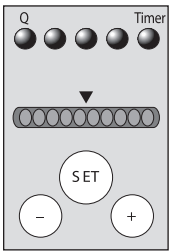

CRT 20B...004

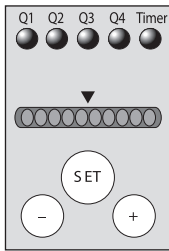

Function indicator LEDs Q/timer (yellow)

Bargraph display (green), Power On = left LED on

Teach-in button (SET), "+" and "-" buttons

**Operation**

During operation, the bargraph display indicates the colour quality, i.e. the degree of matching with the taught colour (with the CRT 20B...004 according to the selected colour channel, see Special settings). If above or below the arrow, the switching output changes its state.

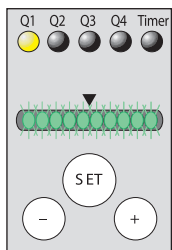

Full match  
Colour detected  
Switching output active

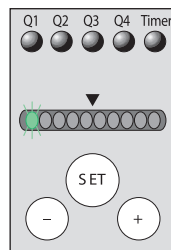

No match  
Colour not detected  
Switching output not active

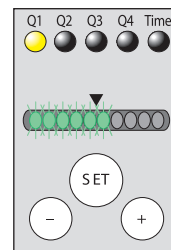

Tolerance edge  
Colour detected  
Switching output active





The colour tolerance can be readjusted during operation:

- To do this, press the "+" button and release after > 1 s.
- Then use "+" or "-" to adjust the tolerance
- Confirm with "SET"



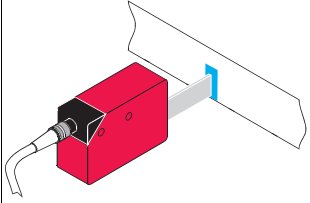

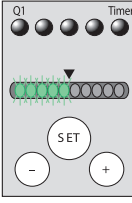

This function can be switched on and off in the special settings (see "Tolerance adjustable during operation"). With the CRT 20B...004, the tolerance refers to the selected channel (see "Quality indicator during operation" under Special settings).

## Teach-in of the switching threshold

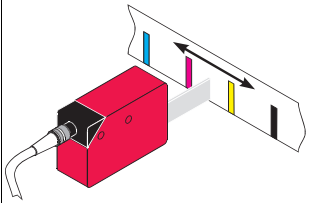
With the CRT 20B...001:

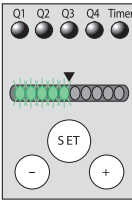
<p>Position colour</p> 	<p>Press SET &gt; 1 s and release</p>  <p>&gt; 1 s</p>	<p>Adjust tolerance with "+" or "-"</p> 	<p>Briefly press SET to confirm</p> 
--	---	---	---

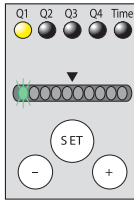
With the CRT 20B...004:

<p>Position colour</p> 	<p>Press SET &gt; 1 s and release</p>  <p>&gt; 1 s</p>	<p>Adjust tolerance with "+" or "-"</p> 	<p>Briefly press SET to confirm</p> 	<p>Select channel with "+" or "-"</p> 	<p>Briefly press SET to confirm</p> 
--	---	---	---	---	---

The teach event must be repeated for each colour that is to be taught. Each colour must be assigned its own channel (Q1-Q4). Alternatively, the teach-in can also be performed via the teach line. The tolerance setting is not performed in this case. With the CRT 20B...004, only channel Q1 is set via the line teach.

**Special settings**

- Simultaneously press the "+" and "-" buttons > 1 s to enter and exit. Active special settings are indicated by flashing of one or more of the Q-LEDs.
- Use "+" or "-" to navigate / make settings
- Use "SET" to select / confirm
- Simultaneously press the "+" and "-" buttons > 5s to reset to factory settings.

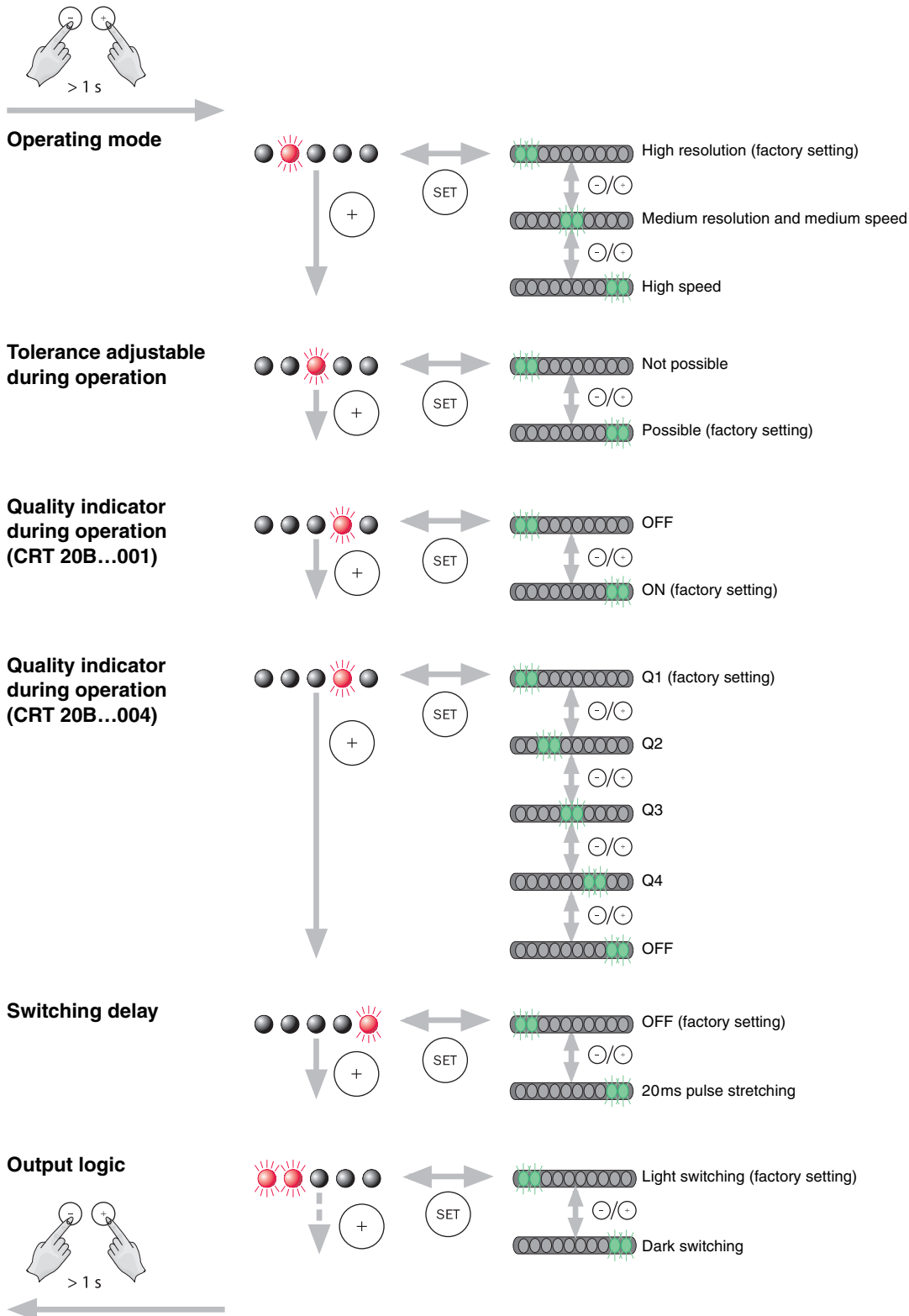

**Preferred types**

Selection table		Order code →							
Equipment ↓		CRT 20B M/N-12-001-S12 Part No. 501 09594	CRT 20B M/N-60-001-S12 Part No. 501 09595	CRT 20B M/P-12-001-S12 Part No. 501 09596	CRT 20B M/P-60-001-S12 Part No. 501 09597	CRT 20B M/N-12-004-S12 Part No. 501 09598	CRT 20B M/N-60-004-S12 Part No. 501 09599	CRT 20B M/P-12-004-S12 Part No. 501 09600	CRT 20B M/P-60-004-S12 Part No. 501 09601
Scanning range	12,5mm	●		●		●		●	
	60mm		●		●		●		●
Light spot size	4mm x 2mm	●		●		●		●	
	13mm x 13mm		●		●		●		●
Light spot orientation	vertical	●	●	●	●	●	●	●	●
	horizontal								
Optical outlet	front								
	head	●	●	●	●	●	●	●	●
Switching output	1x PNP			●	●				
	1x NPN	●	●						
	4x PNP							●	●
	4x NPN					●	●		
M12 connector	5-pin	●	●	●	●				
	8-pin					●	●	●	●
Adjustment	Teach-in via control buttons	●	●	●	●	●	●	●	●
	Teach-in via line	●	●	●	●	●	●	●	●
Options	synchronisation via line	●	●	●	●	●	●	●	●
	20ms pulse stretching	●	●	●	●	●	●	●	●
	light/dark switching for all outputs	●	●	●	●	●	●	●	●

Additional types on request